

Appendix: ASD Macroeconomic Model

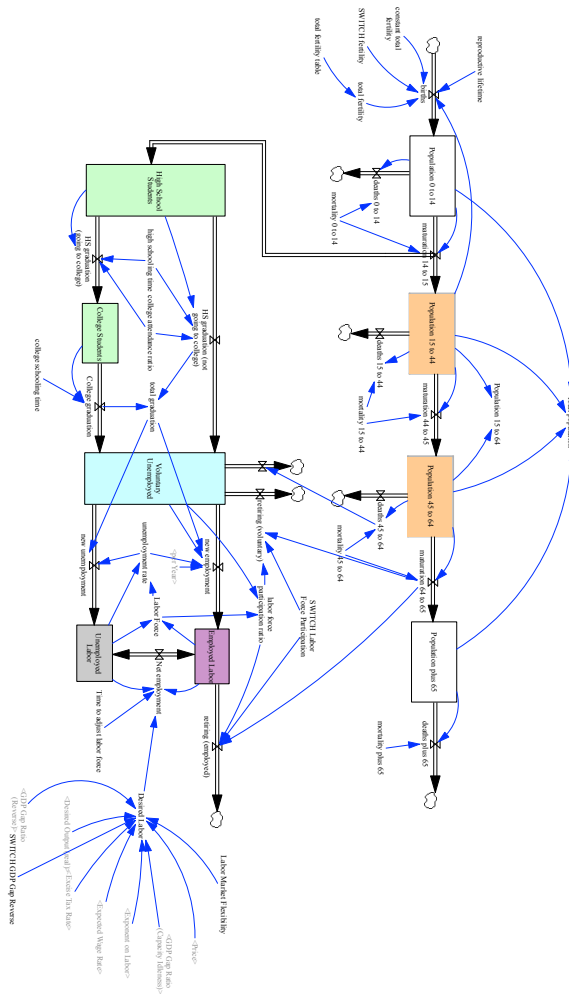

Figure 23: Population and Labor Market

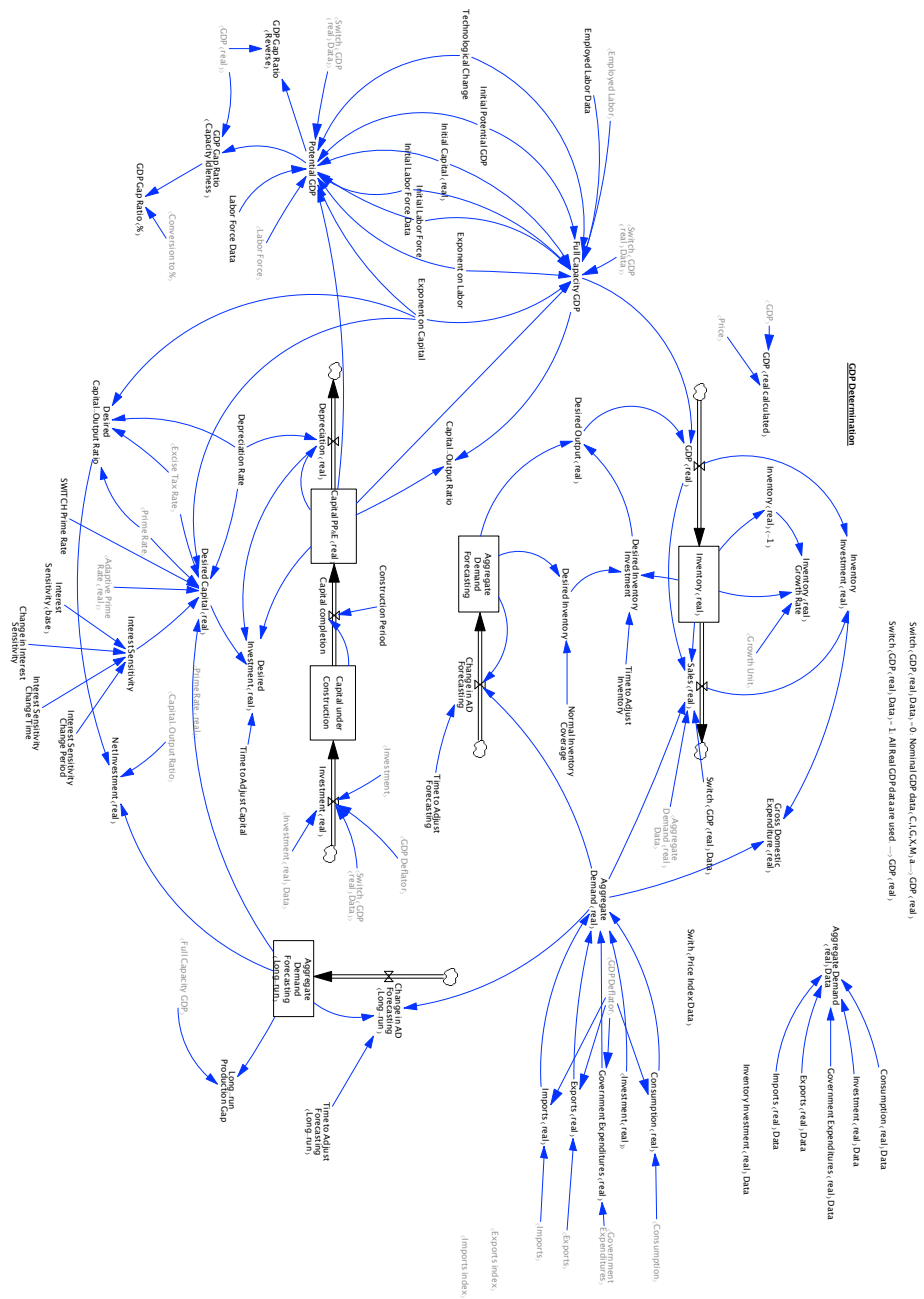

Figure 24: Real GDP Determination

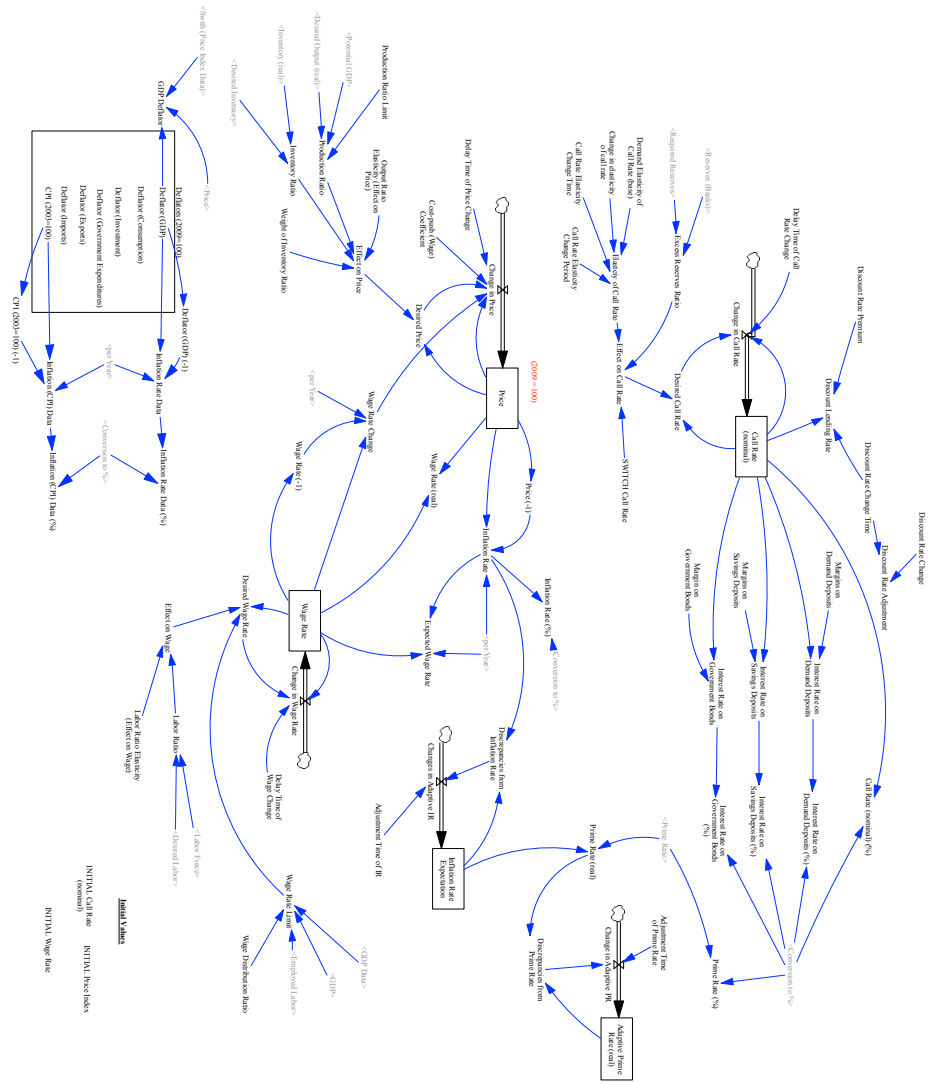

Figure 25: Price and Interest Rate Determination

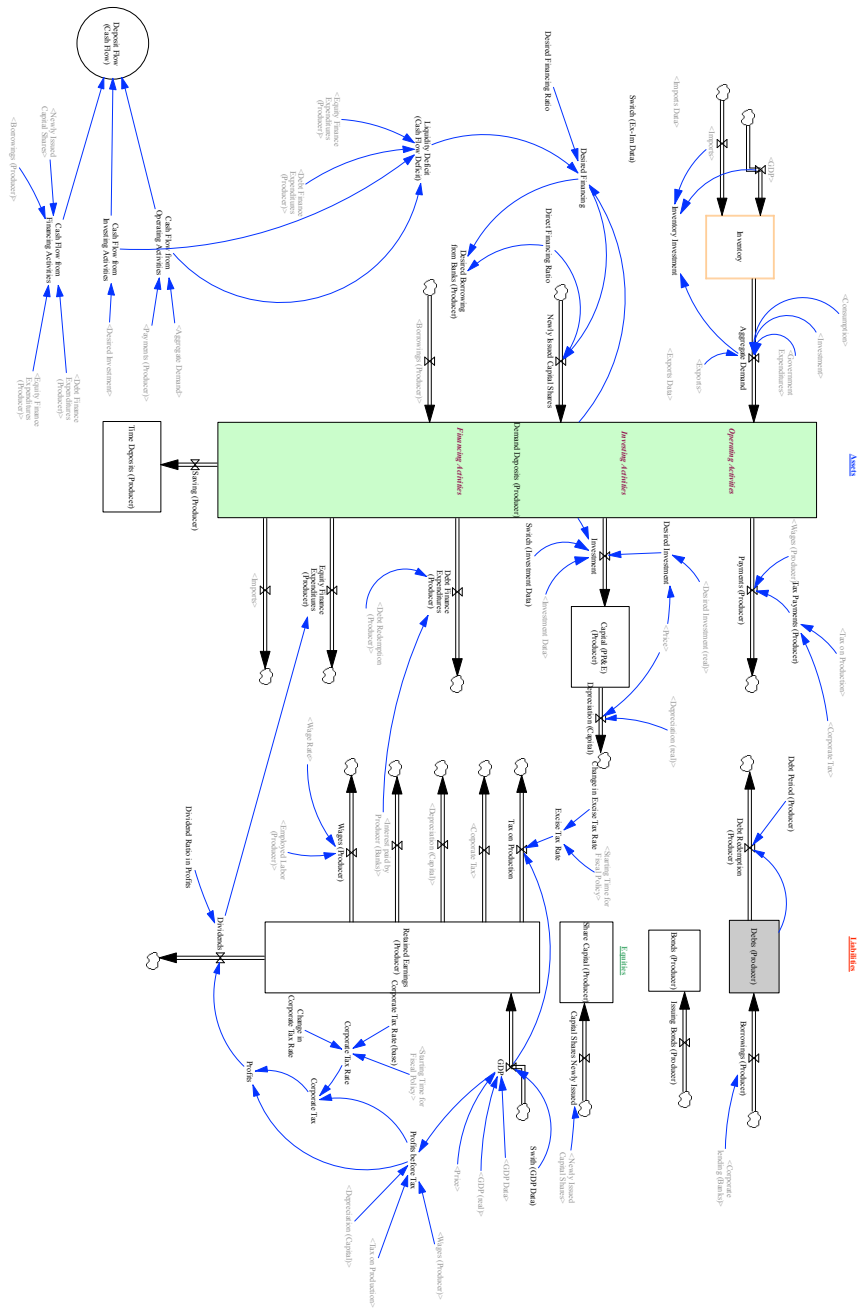

Figure 26: Producers Sector
31

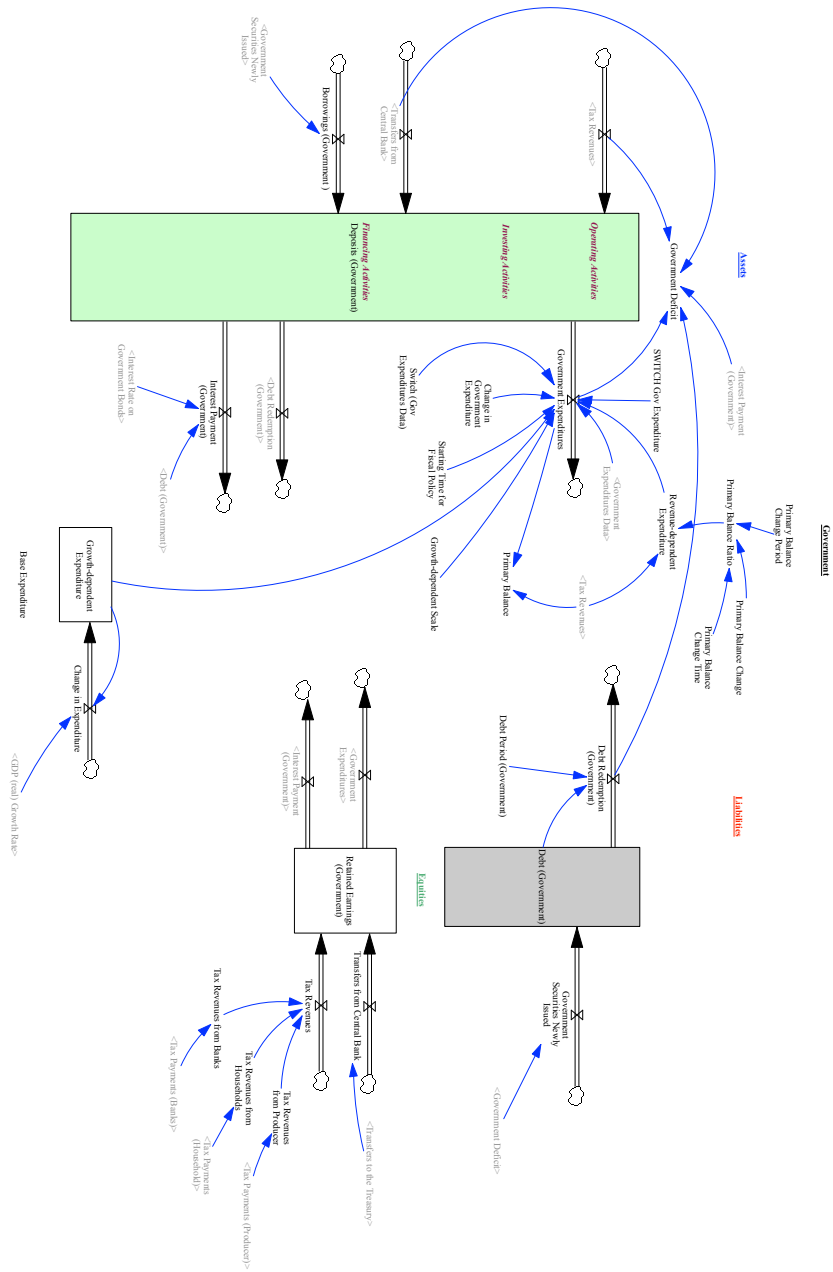

Figure 27: Households Sector

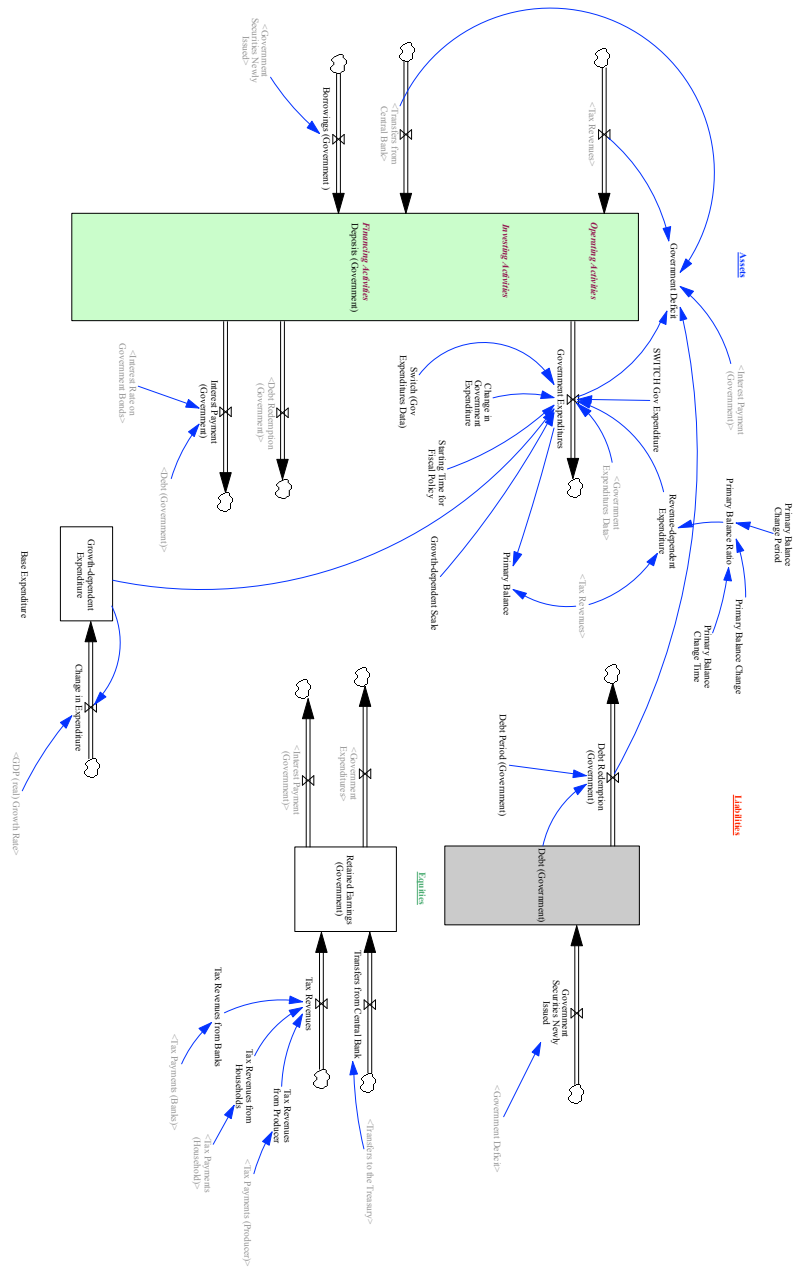

Figure 28: Government Sector

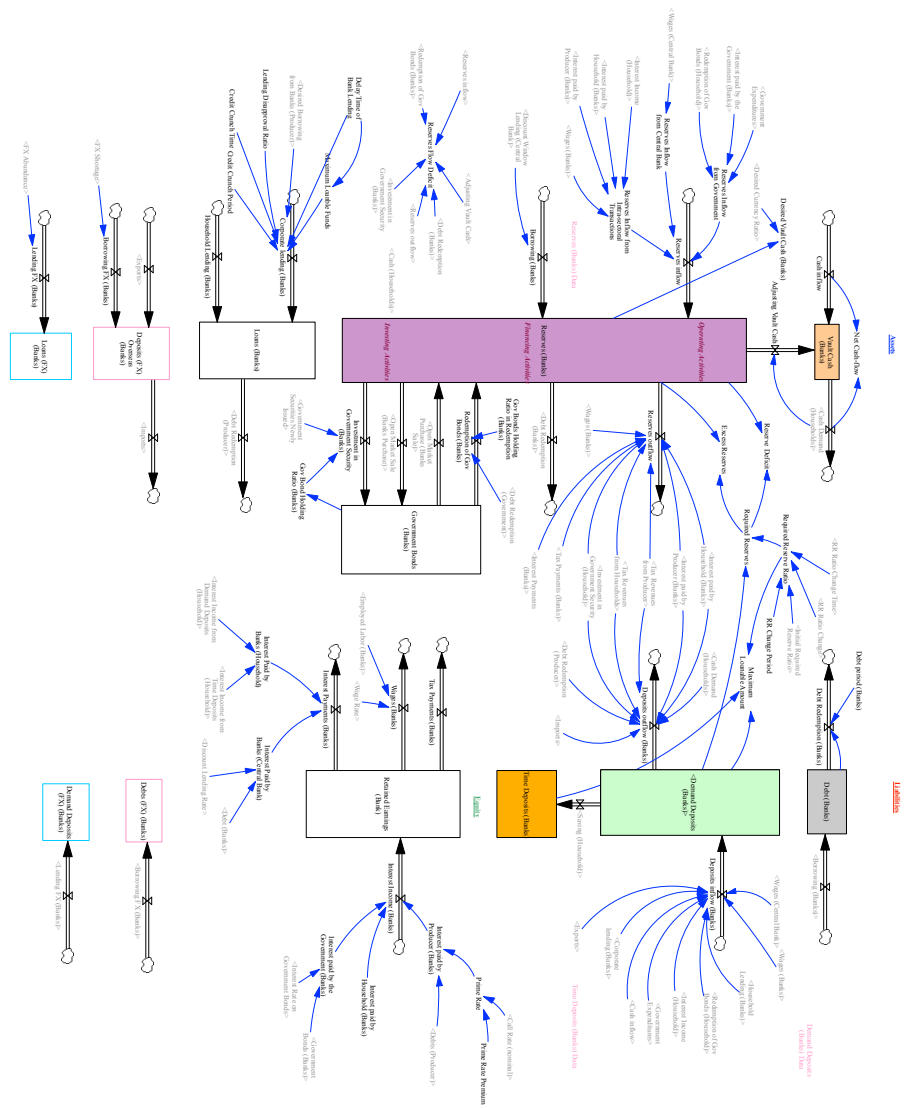

Figure 29: Banks Sector

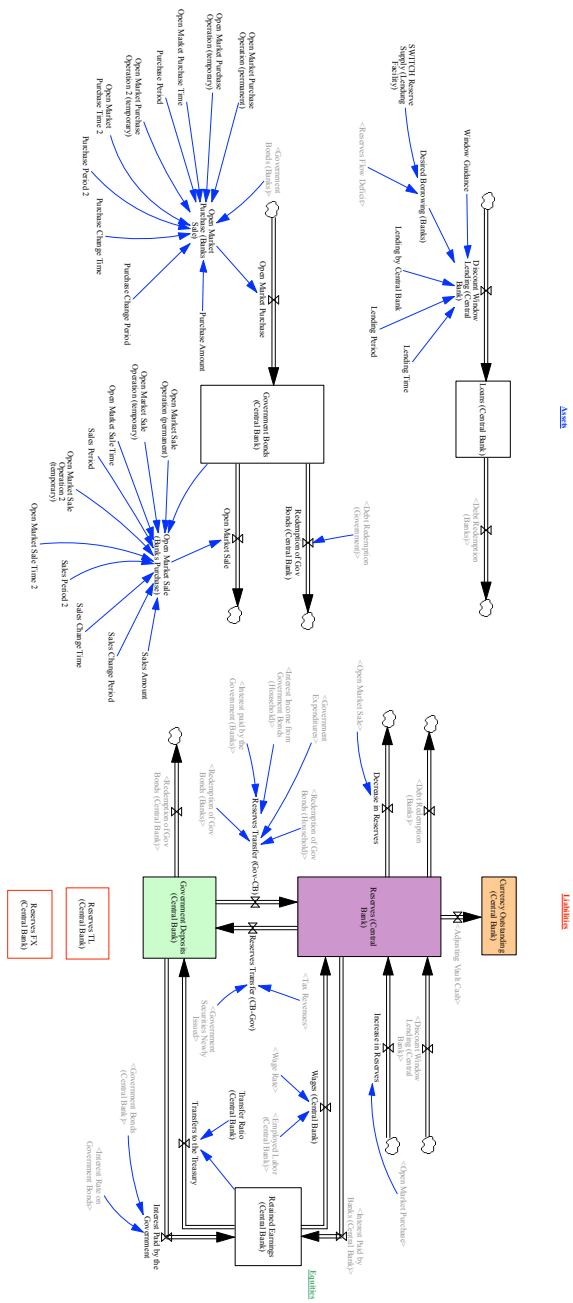

Figure 30: Central Bank Sector