

The Heads and Tails of Money Creation and its System Design Failures – Toward the Alternative System Design –

Kaoru Yamaguchi, Ph.D. *
Yokei Yamaguchi

Japan Futures Research Center
Awaji Island 656-1325, Japan
E-mail: director@muratopia.net

July 18, 2016

Keywords: Accounting System Dynamics, Money Creation, Fractional Reserve Banking, Monetary Instability, QE Failures, Public Money System

The ideas which are here expressed so laboriously are extremely simple and should be obvious. The difficulty lies, not in the new ideas, but in escaping from the old ones, which ramify, for those brought up as most of us have been, into every corner of our minds.

— John M. Keynes [5, 1935]

Abstract

Concerning the creation of money under the current fractional reserve banking system of debt money, two theories have confusingly coexisted among economics profession for more than a century; the one that regards banks as intermediaries of deposits, and the other as credit creators out of nothing. They are based on two different ways of understanding banking processes of money creation, and called here flow and stock approaches of SD modeling, respectively, according to [15, 2013].

*This paper is presented at the 34th International Conference of the System Dynamics Society, Delft, the Netherlands, July 17-21, 2016. The first author is the director of the Japan Futures Research Center, and the second author is the graduate student of the EMSD (European Master in System Dynamics) program. This research is partially supported by the Research Fund of the Japan Futures Research Center: www.muratopia.net. It is a sincere hope of the authors that this paper will be one of the guiding stars out of the current deluded field of economics as social science.

The purpose of this paper is threefold. First, these two approaches are shown to be identical as if they are heads and tails of the coin, bringing century-long confusions to an end. Secondly, using the model of stock approach, the current monetary system is shown to be unstable in the sense that it causes booms and busts and leads to recent failures of QE policy. In other words, the debt money system is demonstrated to entail system design failures.

Thirdly, the alternative monetary system preventing monetary instabilities is fully explored. It is the monetary reform of the Chicago Plan proposed in 1930s after the Great Depression in 1929, whose modern version is known as the *Public Money System*. The alternative system is shown to attain monetary stability. As its by-product, debt liquidation of government is shown to be attained concurrently. Then genuine business model of banks under the alternative system is briefly discussed in which banks become genuine intermediaries.

1 Introduction: System Design of Debt Money

We, the people of the world, are currently forced to live under the so-called *Debt Money System*. In this system money that plays a substantial role for attaining stable economic activities and people's happiness is created as debt at interest. Specifically, central banks make loans to commercial banks and government at interest, while commercial banks make loans to the rest of the non-banking public sector at interest. By making loans, banks (both central and commercial) collect a substantial portion of value-added GDP as unearned interest revenues, causing income inequalities between bankers and the rest of people.

The workings of this debt money system with a focus on money sitting in the center of economic activities is comprehensively analyzed in Yamaguchi [15, 2013] by applying the accounting system dynamics modeling method. In its chapter 5 "Money and Its Creation", the mechanism of money creation under the so-called fractional reserve banking system is modeled through flow and stock approaches. Flow approach regards banks as intermediaries of bank deposits from depositors to borrowers, while stock approach regards banks as credit creators by making loans out of nothing. In this paper we follow the same naming as used in the chapter 5. Without detailed explanation, however, the chapter predicted that both approaches of money creation are identical, leaving the SD modeling work of stock approach partially to the reader as exercise.

Meanwhile, facing repeated financial crises after the so-called second Great Depression triggered by the bankruptcy of Lehman Brothers in 2008, some monetary economists began to throw serious suspicion against the standard textbook view on the role of banks as intermediaries, and tend to argue that the view of banks as credit creators out of nothing is more accurate in consideration of banking practices in real economy. In short, according to their arguments, flow approach is incorrect, and stock approach is correct, contrary to the prediction in the chapter 5 mentioned above that both approaches are identical.

For instance, Richard Werner [14, 2015] classifies the flow approach further into two theories; *the financial intermediation theory of banking* and *the fractional reserve theory of banking*. while the stock approach as *the credit creation theory of banking*. In the working paper of the Bank of England, Jakob and Kumhof [4, 2015] classifies the flow approach as *the intermediation of loanable funds* (ILF), while the stock approach as *financing through money creation* (FMC). Another well-cited "Bank of England" paper [7, 2015] criticizes the flow approach by arguing that "one common misconception is that banks act simply as intermediaries, lending out the deposits that savers place with them."

By classifying the process of money creation in this way, these authors, then, put themselves all in a supporting position of the stock approach by criticizing the view of banks as intermediaries. Accordingly it may be worth while, following Richard Werner [14, 2015], to show how economists have been confused for more than a century among these two or three theories when modeling the magical process of credit creation.

Flow Approach. This approach is further broken down in two sub-approaches. Examples of *the financial intermediation theory* of banking include some well-known economists. They are¹ : Keynes(1936); Gurley and Show (1955); Tobin (1963, 1969); Sealey and Lindley (1977); Balernsperger (1980); Mises(1980); Diamond and Dybvig (1983); Diamond (1984, 1991, 1997); Bernanke and Blinder(1988); Eatwell, Milgate and Newman (1989); Gorton and Pennacchi (1990); Bencivenga and Smith (1991); Bernanke and Gertler (1995); Rajan (1998); Myers and Rajan (1998); Allen and Gale (2004); Allen and Santomero (2001); Diamond and Rajan (2001); Kashyap, Rajan and Stein (2002); Matthews and Thompson (2005); Casu and Girardone (2006); Dewatripont et al. (2010); Gertler and Kiyotaki (2011); Stein (2014); Carney(2014) and Krugman (2015).

Examples of *the fractional reserve theory* of those who argue that banking system creates money through the process of 'multiple-deposit creation' are: Hayek (1929); Samuelson(1948); Gurley and Show (1955); Warren Simith (1955); Gulbertson (1958); Aschheim (1959); Solomon (1959); Paul Smith (1966); Guttentag and Lindsay (1968); Stiglitz(1997).

Stock Approach: Examples of *the credit creation theory* are: Macleod(1856); Wicksell (1989); Withers(1909, 1916); Schumpeter (1912); Cassel (1918); Hahn (1920) Hawtrey (1919); Howe(1915); Gustav Cassel(1923); Macmillan Committee(1931); Fisher(1935); Rochon and Rossi(2003); Werner(2005); Bank of England [7, 2014]; Jakob and Kumhof [4, 2015].

It is interesting to observe from these lists of economists that the stock approach disappeared entirely since Irving Fisher [1, 1935] till quite recently as if it has been a *taboo subject* (Adair Turner [13, p.31, 2013]). The purpose of this paper is, first, to show that both flow and stock approaches are identical as if they are heads and tails of the same coin, bringing century-long confusions of economists to an end. Secondly, it is demonstrated that the debt money system is poorly designed such that monetary instability is inescapable, causing booms

¹References of these economists quoted here under flow and stock approaches are not listed in the references of this paper. Please refer to the original Werner paper [14, 2015] for detailed references.

and busts, economic recessions and unemployment, income inequalities, etc. As the alternative system design, thirdly, the public money system developed in [15, 2013] and [16, 2015] is more concisely introduced along the framework of stock approach modeling of money creation built in this paper, with a focus on monetary reform proposals, known collectively as the Chicago Plan, made by Irving Fisher, etc. in 1930s after the Great Depression in 1929.

This paper is organized as follows.

heads and tails of Money Creation. Section 2 through 6 are devoted to demonstrate that flow and stock approaches of money creation are identical as if they are heads and tails of the same coin. Specifically, section 2 defines money as legal tender by following the Greek philosopher Aristotle. Section 3 explains how accounting entries are treated when deposits are either created or destroyed. It also presents an important step for understanding what bank deposits are in legal sense, then concludes that deposits created under the fractional reserve banking are not legal tender but *functional-money out of nothing*. Section 4 and 5 investigate flow and stock approaches of commercial banking and money creation process, respectively. In section 6 those two approaches are shown to be identical.

System Design Failures. Section 7 through 9 are devoted to show that the current debt money system based on the fractional reserve banking system entails system design failures. Specifically, in section 7 instability of deposits are revealed in terms of liquidity preferences, lending behaviors of banks, and destruction of deposits by debt repayment, followed by the case study of bubbles and bursts in Japan in 1990s. Section 8 focuses on the impediment to QE policies, followed by the examination of failures of QE policies in Japan. In section 9 unearned interest revenues are pointed out to be built-in driving forces toward system design failures.

The Alternative System Design. Finally section 10 is devoted to present the alternative system design to the current debt money system. This alternative system design, featured by the 100% required reserve, was originally proposed as the monetary reform of banking or the Chicago Plan in 1930s after the Great Depression in 1929. Under the alternative system it is shown that monetary instability is removed, and, as a by-product, government debt is gradually liquidated. Its modern version is proposed as the *Public Money System* in [15] in which the public money administration manages public money stock independently of the influences by government and vested interest groups.

2 Base Money as Legal Tender

2.1 Aristotle's Definition of Money

What is money? Where does it come from? These are fundamental questions that have been repeatedly raised through human history. *The Lost Science of Money* by Zarlenga [18, 2002] is one of the best books on money for authentic economists to explore these questions. In the book, Greek philosopher Aristotle

(384-322 BC) is quoted to have articulated money as follows:

and this is why it has the name *nomisma* - because **it exists not by nature, but by law (*nomos*)** and it is in our power to change it and make it useless. [18, p.34].

Following Aristotle, we define money similarly as *legal tender*. What is *legal tender*, then? Legal tender is money that people cannot refuse to accept in exchange for commodity. In other words, money is *legal tender* that coflows along with commodity inseparably as illustrated in Figure 1.

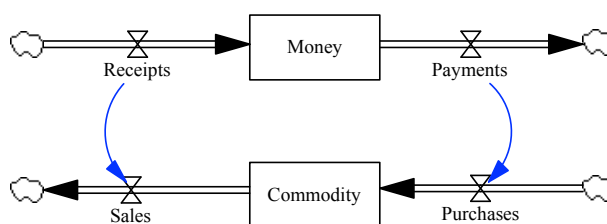

Figure 1: Coflow of Money and Commodity

From SD modeling point of view, in order to model coflows of money and commodity, we need at least following three pieces of information on money: money as stock, its unit to define the amount of stock, and its flow amount as a medium of exchange for commodity. Hence, from these modeling requirements we can easily derive three essential functions of money as explained in many standard textbooks²:

- Unit of Account (unit of money stock has to be determined before modeling)
- Medium of Exchange (flow amount of money stock has to be determined to coflow commodity)
- Store of Value (money has to be modeled as the amount of stock)

In short, money has to be declared as legal tender first of all. Whenever it is put into circulation, then, it begins to entail three inevitable functions mentioned above, not *vice versa* at all. It can be easily understood consequently that SD modeling method is essential for the dynamic description of money.

Unfortunately, however, Adam Smith (1723-1790), known as the father of economics, reversed the definition of money by Aristotle as follows:

²One more important function of money is that it plays as *means of control*. Historically those who lend money have been always in a position to control borrowers as their debt slaves. This means of control is fully analyzed in the recent Japanese book [16, 2015].

By the money price of goods it is to be observed, I understand always, *the quantity of pure gold and silver* for which they are sold, without any regard to denomination of the coin. [18, p.313].

In this way, Adam Smith reversely defined money as commodity. Advancing his idea more axiomatically, many textbooks currently define money as the entity that meets the above three functions. According to this axiom of money, gold and silver are best qualified as ideal money *by nature*, because their physical nature meets three functional conditions of money perfectly. This reversed definition of money has become a root cause of confusion for economists as well as ordinary people who are heavily influenced by them.

According to the double-entry bookkeeping rule of accounting, commodity transaction with cash money in Figure 1 can be described in Table 1 as follows.

Buyers		Sellers	
Debit (Assets)	Credit (Assets)	Debit (Assets)	Credit (Assets)
Commodity (+)	Cash (-)	Cash (+)	Commodity (-)

Table 1: Journal Entries of Transaction with Cash

In this transactions, buyers have to give up their cash assets to increase their commodity assets, while for sellers commodity assets have to be given up to increase their cash assets. In short, commodity transactions with cash are always booked as increase and decrease of assets simultaneously.

2.2 Issuance of Legal Tender

In order to define money as legal tender, there must be specific laws that stipulate the issuance of money legally. In Japan "Currency Unit and Money Issuance Act (revised in 1987)" enables the government to issue coins (called money) by a unit of yen (¥); that is, 1, 5, 10, 50, 100 and 500 yen coins. On the other hand, "Bank of Japan Act (revised in 1997)" enables the Bank of Japan, a privately owned central bank³ with 55% ownership of the government, to issue "Bank of Japan Note" with denominations of 1000, 2000, 5000 and 10000 yen notes. The reader is advised to examine his or her nation's monetary laws that stipulate money as legal tender.

Consequently, in Japan *currency*, consisting of the Government *coins* and Bank of Japan *notes*, is specifically defined by law as legal tender such that it

³The expression "a privately owned" here means that the shares of Bank of Japan are owned by private individuals and institutions and freely traded in the stock market. Yet, there is no annual shareholders' meeting held in by the Bank of Japan. National Bank of Belgium, on the other hand, holds annual shareholders' meeting and its shares are traded in the stock market. For a brief comparative survey on differences of central bank ownership around the world, see Rossouw [10, 2014].

cannot be refused to accept as a means of payment; that is why it is alternatively called *fiat money*. Figure 2 illustrates the state of currency (coins and notes) as legal tender.

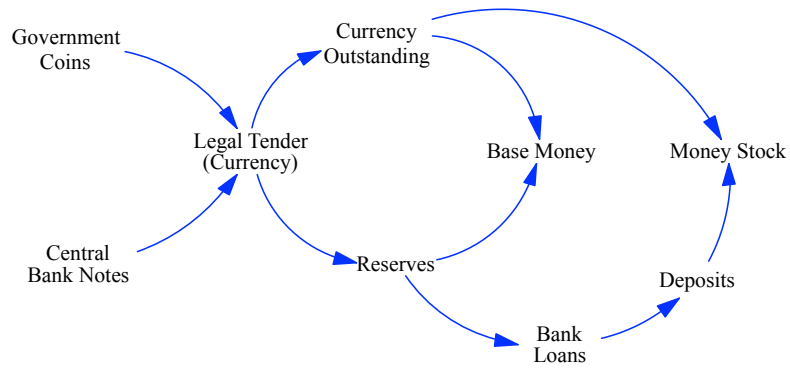

Figure 2: Base Money as Legal Tender

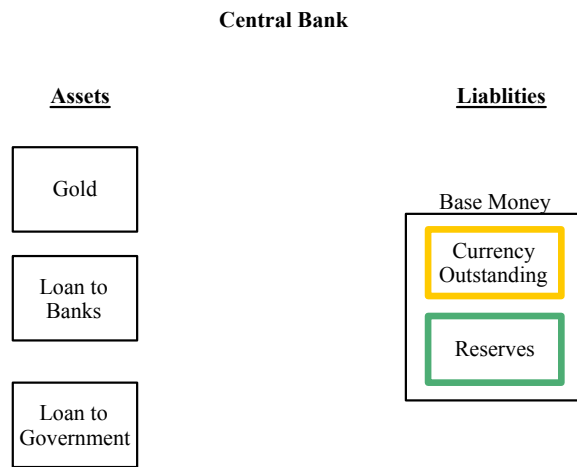

Figure 3: Issuance of Base Money Backed by Various Types of Asset

Once currency as legal tender is being put into circulation under the current fractional reserve banking system, it begins to be split into two parts: currency

outstanding and reserves with the central bank. The sum of these parts are called *base money*⁴:

$$\text{Base Money} = \text{Currency Outstanding} + \text{Reserves} \quad (1)$$

Hence, base money is by definition legal tender as illustrated in Figure 2.

Although central bank is legally allowed to issue base money, it can issue base money only when someone comes to borrow at interest. Those who come to borrow from the central bank are mainly commercial banks and government. Accordingly, the practice of issuing base money through various lending facilities or asset purchases is illustrated in Figure 3 by the double-entry accounting rule.

As this figure illustrates, base money is booked as liabilities in the balance sheet of the central bank, and backed by various types of assets such as gold, discount loan to commercial banks and loan to the government (securities).

3 Deposits as Functional-Money out of Nothing

Under the current debt money system of fractional reserve banking, banks can create deposits out of nothing by granting loans to non-banking public sector. Deposits thus created are used for transactions as if they are money as illustrated in Figure 4.

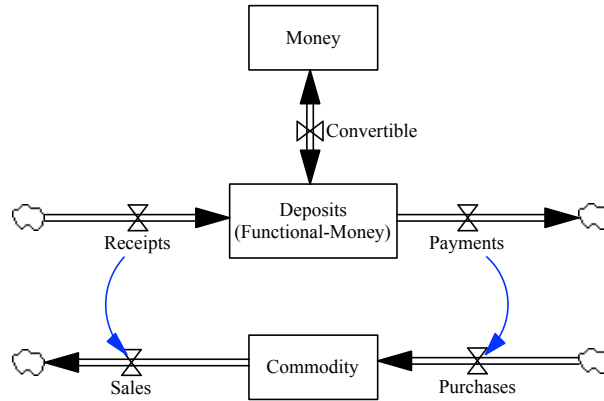

Figure 4: Deposits as Functional-Money

According to the double-entry accounting rule, this transaction is booked in Table 2 as follows.

⁴Base money is alternatively called *monetary base*. In this paper we use the name of "base money", because "monetary base" gives us a misleading impression that bank deposits, being created out of monetary base as explained below, constitute the expanded base of currency as legal tender. Base money could be more precisely named *legal money*.

Buyers		Sellers	
Debit (Assets)	Credit (Assets)	Debit (Assets)	Credit (Assets)
Commodity (+)	Deposits (-)	Deposits (+)	Commodity (-)

Table 2: Journal Entries of Transaction with Deposits

Hence all transactions are booked within the account of assets as in Table 1. Does this mean that deposits, created out of nothing through loans, become legal tender, similar to cash, such that no one can refuse to accept? According to Masaaki Shirakawa, former governor of the Bank of Japan, the answer is negative.

Contrary to the central bank notes, creditors can refuse to accept bank deposits as the payments of debt obligations because of credit risks associated with bankruptcies of debtors' banks. However, in normal times, bank deposits **function as money** because of creditors' confidence that bank deposits can be converted to central bank notes [12, p.13] (translated by the authors).

What is meant here is that deposits are accepted for commodity transaction in Figure 4 only when their convertibility assumption with money is presumed by their recipients. In this sense, they are not legal tender. Henceforth, deposits are in this paper regarded as *functional-money*, and the misleading naming of "credit creation" that has been used in standard textbooks is replaced with "functional-money creation".

Assuming that *deposits function as money*, standard textbooks define another concept of *monetary aggregate* in addition to *money* as

$$\text{Money Stock} = \text{Currency in Circulation} + \text{Deposits} \quad (2)$$

Money stock thus defined is the total amount of money available in the economy as medium of exchange, regulating transactions and economic activities.

On the other hand, though this concept of money stock is theoretically rigorous to capture the amount of money available in the economy, it is hard to calculate it statistically in practice. Accordingly, money stock is practically obtained more easily according to the monetary data available at the central bank and commercial banks by the following formula:

$$\text{Money Stock (Data)} = \text{Currency Outstanding} + \text{Deposits} \quad (3)$$

This relation is illustrated in the above Figure 2. The difference of these two definitions is "vault cash" held by commercial banks such that

$$\text{Currency Outstanding} = \text{Currency in Circulation} + \text{Vault Cash (Banks)} \quad (4)$$

Money stock thus defined begin to play a role as money as if it is legal tender under the assumption of its convertibility with money.

Base Money and Money Stock in Japan

So far we have introduced basic concepts of money such as base money and money stock. In actual monetary analysis, money stock is further classified according to the nature of deposits. For instance, the Bank of Japan defines various concepts of the amount of money as follows.

- M_0 = Base Money
- M_1 = Currency Outstanding + Demand Deposits
- $M_2 = M_1 + \text{Quasi-money} + \text{CD (Certificate of Deposit)}$
(Quasi-money = Time Deposits + Foreign Exchange Deposits,
excluding the Japan Post Bank, Japan Agricultural Cooperatives, etc.)
- $M_3 = M_1 + \text{Quasi-money} + \text{CD (Certificate of Deposit)}$

In Figure 5, M_0 , M_1 and M_3 are illustrated by lines 1, 3 and 2 respectively. GDP (broken line 4) is additionally drawn to compare real economic activities with the various amounts of money that support them.

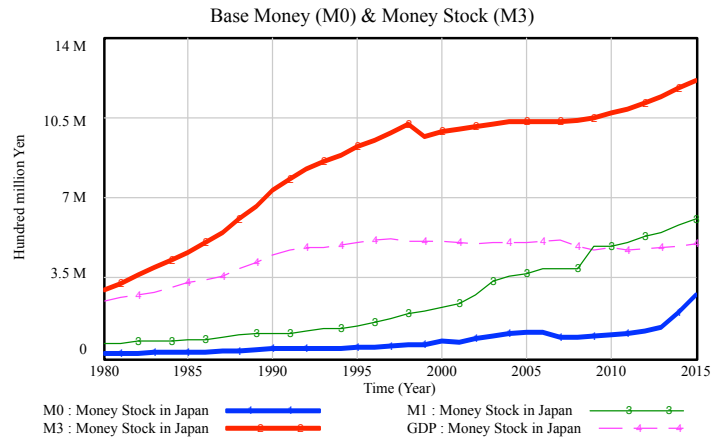

Figure 5: Japan's M_0 , M_1 and M_3 (1980-2015)

4 Flow Approach of Functional-Money Creation

4.1 Fractional Reserve Banking

Flow approach of functional-money creation is fully modeled with accounting system dynamics method in Chapter 5 of Yamaguchi [15] on which our model in this section is based. However, a role of the central bank as the depository bank

for the government is newly added in this paper without changing behaviors of the government, central bank and commercial banks. Let us briefly explain our flow approach model here. It assumes that commercial banks run their primary business by accepting savings (deposits) from depositors and making loans to investors.

Accordingly, banks are assumed to be intermediaries just like other financial institutions and nothing more. Let us explain this banking practice as intermediaries by illustrating Figure 6. The itemized numbers below are the same as those in the figure.

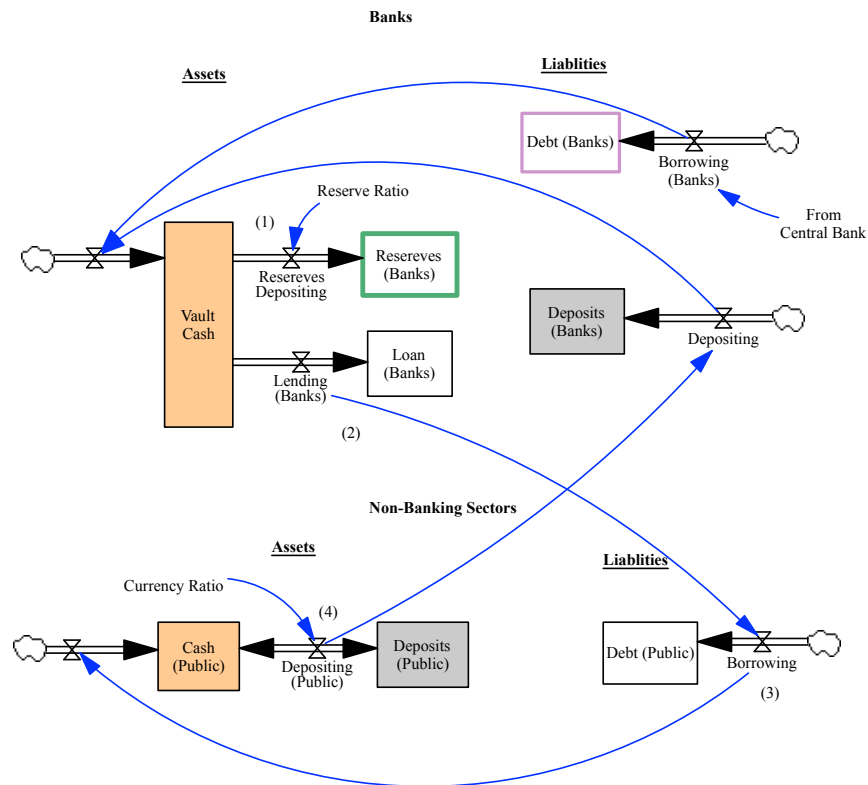

Figure 6: Flow Approach of Money Creation

(1) First, banks collect deposits from the non-banking public sector consisting of households, producers and non-banking financial institutions in our model. Under the current fractional reserve banking system, a portion of deposits thus collected is required to be reserved with the central bank to avoid risks of cash deficiencies according to a required reserve ratio such that

$$\text{Reserve Ratio } (\beta) = \frac{\text{Reserves}}{\text{Deposits}} \quad (5)$$

(2) Then, the remaining amount of deposits are loaned out to the borrowers.

(3) Now borrowers receive cash as assets.

(4) Since the public as a whole needs not to hold all the amount of cash at hand as liquidity⁵, a portion of cash is deposited with banks according to its currency ratio(α) such that

$$\text{Currency Ratio } (\alpha) = \frac{\text{Currency in Circulation}}{\text{Deposits}} \quad (6)$$

Hence one dollar is further divided between currency in circulation and deposits according to the following proportion:

$$1 \Rightarrow \begin{cases} \frac{\alpha}{\alpha+1} & : \text{Currency in Circulation} \\ \frac{1}{\alpha+1} & : \text{Deposits with Banks} \end{cases} \quad (7)$$

Let us now consider how one dollar put into circulation keeps being used for transactions. From the equation (7), $1/(\alpha+1)$ dollars are first deposited, out of which commercial banks are allowed to make maximum loans of $(1-\beta)/(\alpha+1)$ dollars. This amount will be put into circulation again as a loan to the non-banking public sector. In a capitalist market economy, producers in the non-banking public sector is always in a state of liquidity deficiency. In this way, one dollar put into circulation keeps being loaned out repeatedly for transactions. The accumulated total sum of money stock put into circulation through bank loans is calculated as follows.

Accumulated money stock put into circulation through bank loans

$$\begin{aligned} &= 1 + \frac{1-\beta}{\alpha+1} + \left(\frac{1-\beta}{\alpha+1}\right)^2 + \left(\frac{1-\beta}{\alpha+1}\right)^3 + \dots \\ &= \frac{1}{1 - \frac{1-\beta}{\alpha+1}} \\ &= \frac{\alpha+1}{\alpha+\beta} \end{aligned} \quad (8)$$

To understand this magical amount, let us define High-Powered Money as

$$\text{High-Powered Money} = \text{Currency in Circulation} + \text{Reserves}, \quad (9)$$

which is also legal tender by definition. From the equations (1) and (4) the difference between Base Money and High-Powered Money becomes "vault cash"

⁵Among the non-banking public sector, producers and financial institutions tend to borrow for real and financial investment, while households tend to save out of their income revenues.

Money stock thus calculated includes deposits as functional-money. To calculate a portion of legal tender out of money stock in circulation, equation (12) can be rewritten as

$$\text{High-Powered Money (as legal tender)} = mc * \text{Money Stock} \quad (13)$$

in which mc is defined as *money convertibility* coefficient. The coefficient thus defined is obviously a reciprocal of money multiplier m .

Under the default assumption of coefficient values in our model; that is, $\alpha = 0.2$ and $\beta = 0.1$, money multiplier becomes $m = \frac{0.2+1}{0.2+0.1} = 4$, and money convertibility coefficient becomes $mc = 0.25^6$. That is to say, only 25% of money stock (as *functional-money*) could be convertible to *genuine money* as legal tender. This implies under the fractional reserve banking in our model, for instance, only 25% of money stock in circulation for transactions could be convertible to legal tender.

Money Multiplier and Convertibility Coefficient in Japan

With the introduction of money multiplier and money convertibility, it is worthwhile to examine how these values actually have taken place in Japan. As the left-hand diagram of Figure 8 indicates, money multiplier in Japan has been between 15 and 20 from 1980 through 2000, then, begins to decline due to the QE policies to be discussed below. On the other hand, money convertibility coefficient in Japan has been less than 7% from 1980 through 2000, then, begins to increase thanks to the QE policies as shown in the right-hand diagram. In 2015 it became 23%. Yet, this implies Japanese depositors can only convert 23% of their deposits to genuine money as legal tender in case of bank-runs. Indeed we are forced to live in a fragile economic edifice constructed on shaky deserts.

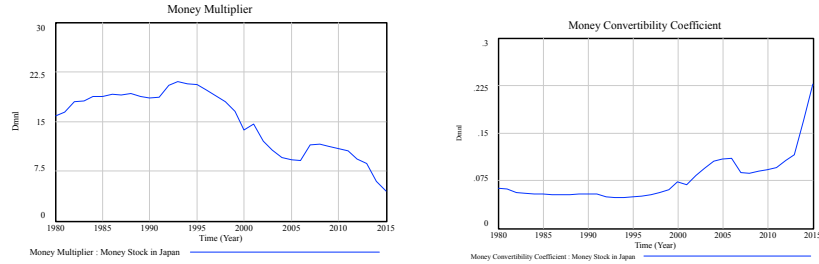

Figure 8: Money Multiplier and Convertibility Coefficient in Japan

⁶When $\beta = 1$ (100% reserve) under the public money system to be discussed in Section 10 below, we have $m = mc = 1$ so that the entire amount of money stock in circulation becomes legal tender.

4.2 Accounting Presentation of Flow Approach

Banks in practice as intermediaries is now described according to the double-entry bookkeeping rule. In the flow approach, bank loans do not seem to create deposits, simply because they are assumed to make loans out of cash assets in the model as shown in top left balance sheet of Banks in Table 3. In other

Banks		Non-Banking Public Sector	
Debit (Assets)	Credit (Assets)	Debit (Assets)	Credit (Liabilities)
Loan (+)	Cash (-)	Cash (+)	Debt (+)

Debit (Assets)	Credit (Liabilities)	Debit (Assets)	Credit (Assets)
Cash (+)	Deposits (+)	Commodity (+)	Cash (-)

Table 3: Journal Entries of Flow Approach in (2) and (3)

words, banks increase their loan assets to gain interest revenues by giving up their own cash assets. This transaction seems fair and reasonable as a profit-seeking management out of their cash assets.

Where does that cash come from, then? Surely it is tied with deposits as shown in the bottom left balance sheet of Banks. When cash accounts are cancelled out in this balance sheet, bank loan (debit of assets) can be said to be balanced by deposits (credit of liabilities)⁷. Under the situation, can the banks, then, make loans out of these deposits at their disposal? If deposits are time deposits entrusted with banks by savers for better financial management, then the answer is surely "Yes, they can". But if deposits are demand deposits for transactional purposes, then the answer should be "No, they cannot", because banks are obliged to hold them anytime to meet withdrawal requests from depositors.

Accordingly, it becomes fraudulent to make loans out of demand deposits. Yet, Irving Fisher once pointed out: "When money is deposited in a checking account (i.e. demand deposits), the depositor still thinks of the money as his, though *legally it is the bank's* (italicized by the authors). [1, p.12, 1935]." Hence, deposits are legally owned by banks and they can make loans out of depositors' money⁸. In this way, fraudulent-looking loans out of depositors' money have been made legitimate under the fractional reserve banking system.

Hence, in the flow approach deposits (or credit) creation process out of nothing is masqueraded behind the double-entry bookkeeping practice of making loans out of cash. That is why this flow approach of banking practice has been deliberately supported so that many economists as well as ordinary people have been enticed to believe that banks are not creating money out of nothing, but

⁷Whenever transactions are traced back in this way, balance sheet of flow approach becomes structurally the same as that of stock approach as shown in Table 5 below. In the flow approach, loans are made out of deposits (Deposits→Loan), while in the stock approach, deposits are made out of loans (Loan→Deposits).

⁸In Japan this practice is guaranteed by Article 590, Civil Code.

merely intermediating money between lenders and borrowers as a long list of economists under flow approach in Section 1 indicates..

When cash keeps being loaned out in circulation as explained above, deposits simultaneously gets accumulated as well. These accumulated deposits are used for transactions in the non-banking public sector, though they are not legal tender, as if they are functional-money (or convertible to money) as illustrated in Figure 4. In other words, cash and deposits gets interchangeably used for transactions; that is, buyers and sellers keep their transactions as recorded in Table 4. In reality, transactions through deposits occupy a large portion of economic activities.

Buyers		Sellers	
Debit (A)	Credit (A)	Debit (A)	Credit (A)
Commodity (+)	Cash (-)	Cash (+)	Commodity (-)
Commodity (+)	Deposits (-)	Deposits (+)	Commodity (-)

Table 4: Transactions of Non-Banking Sectors: Flow Approach

Surely these deposits are created out of nothing through fraudulent practice of loans out of depositors' money under the fractional reserve banking system.

5 Stock Approach of Functional-Money Creation

Let us now explore the stock approach of lending practice of banks illustrated by Figure 9. The itemized numbers below are the same as those indicated in the figure.

- (1) Whenever banks collect deposits, they reserve the entire amount of deposits with the central bank⁹.
- (2) Under the fractional reserve banking system, banks try to lend maximum loanable funds according to the following formula¹⁰:

$$\begin{aligned}
 & \text{Maximum Loanable Funds (Banks)} \\
 &= \frac{\text{Reserves (Banks)}}{\text{Required Reserve Ratio}} - \text{Deposits (Banks)} \\
 &= \frac{1 - \beta}{\beta} \text{Reserves (Banks)} \tag{14}
 \end{aligned}$$

⁹In the stock approach model, deposits are assumed to go directly into "Reserves (Banks)". In practice, when customers put deposits at the bank, they are first debited as "Cash (Banks)" instead of "Reserves (Banks)" as in the flow approach. Deposits of cash in the stock approach are assumed to be directly debited as Reserves, and the amount of Vault Cash is later adjusted according to liquidity demand by non-banking sector.

¹⁰The last equation holds only when bank's deposits are fully reserved with the central bank; that is, Deposits(Banks) = Reserves(Banks).

- (3) Banks enter this amount of loans as deposits with borrower's deposits account. This lending practice of loans differs from the flow approach in which borrowers receive real cash instead of deposits as digital number in their account. In this way, banks can create $\frac{1-\beta}{\beta}$ factors of functional-money out of nothing for a unit increase in deposits, or, vice versa, they can destroy $\frac{1-\beta}{\beta}$ factors of functional-money for a unit decrease in deposits. For example, a consumer's withdrawal of \$1 destroys \$9 of functional-money when $\beta = 0.1$, and vice versa.
- (4) Borrowers withdraw cash out of their deposits account according to the currency ratio(α), then the remaining amount is deposited again.

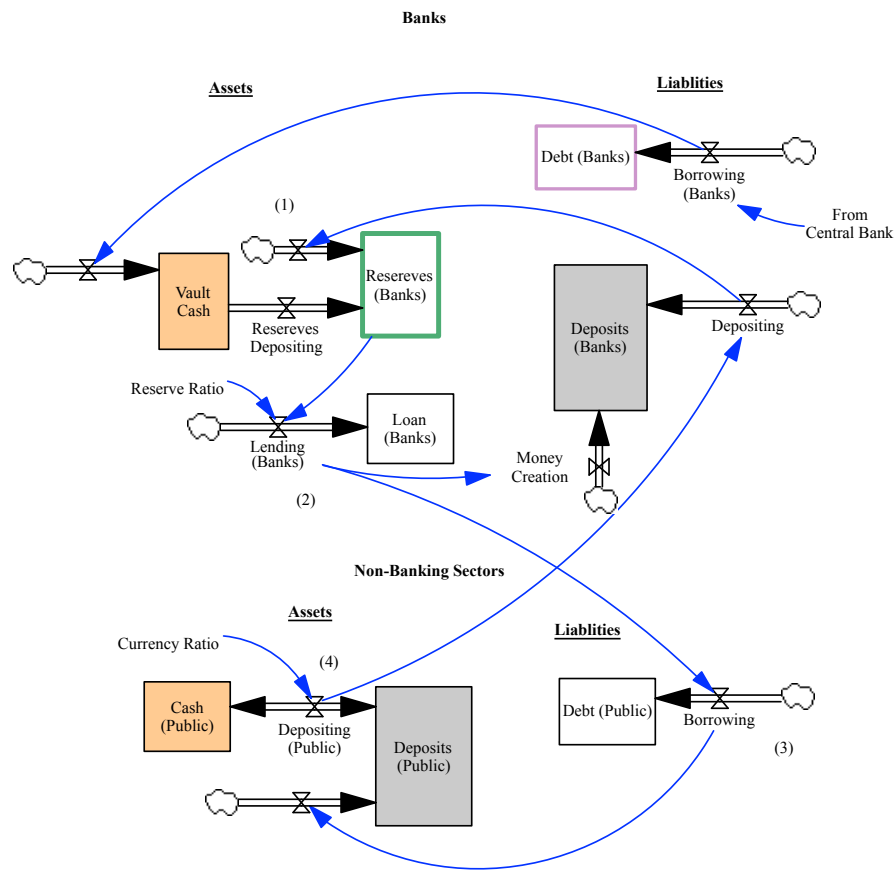

Figure 9: Stock Approach of Money Creation

5.1 Accounting Presentation of Stock Approach

Banking practice of this stock approach is now described according to the double-entry bookkeeping rule as follows.

Banks		Non-Banking Public Sector	
Debit (Assets)	Credit (Liabilities)	Debit (Assets)	Credit (Liabilities)
Loan (+)	Deposits (+)	Deposits (+)	Debt (+)
		Debit (Assets)	Credit (Assets)
		Commodity (+)	Deposits (-)

Table 5: Journal Entries of Stock Approach in (2) and (3)

It may be worthwhile at this stage to explain the difference between flow and stock approaches in terms to accounting principle. In the flow approach, banks' loan (+) (debit assets) is increased at the cost of cash (-) (credit assets), while in the stock approach, banks' loan (+) (debit assets) is increased simultaneously with the deposits (+) (credit liabilities). In other words, in the flow approach assets of banks are cancelled out, while in the stock approach without sacrificing the cash assets banks can increase loan assets by increasing deposits as liabilities out of nothing, and increase their interest revenues in an unearned fashion.

Is this *free-lunch* practice of bookkeeping acceptable? In the open letter to FASB, IASB, and IFAC¹¹, M. Schemmann pointed out:

The creation of units of account by MFIs (monetary financial institutions) that are masquerading as demand deposits defined by the FASB's ASC 305-10-20 as "cash in bank" do not comply with GAAP (Generally Accepted Accounting Principles) or IFRS (International Financial Reporting Standards), Michael Schemmann [11, 1st May 2013, p.2]

In other words, "demand deposits are created *bank-internally* and therefore in violation of **self-dealing** (p.2)"; that is to say, free-lunch is fraudulent and against economic principle of transactions! Accordingly, he continues, "Such internally created units of account are not transferable among banks because they are unique to the MFI that created the units of account in their books of account, and can only be offset in what MFIs call their payment clearing" (p.3)". This implies that deposits are not "legal tender", supporting the quoted statement in Section 3 by the former governor of the Bank of Japan that "deposits are functioning as money".

Moreover, deposits thus created are not literally liabilities to the banks. As Irving Fisher pointed out in the previous section, "*legally it is the bank's*".

¹¹FASB = Financial Accounting Standards Board, IASB = International Accounting Standards Board, IFAC = International Federation of Accountants

Therefore, deposits are legally not liabilities or obligations to the banks. Stock approach unquestionably reveals the free-lunch nature of loan→deposits out of nothing, tied with the increase in unearned interest revenues. To hide away this inconvenient fact, flow approach has been favorably used in the textbooks so that banks can pretend to be intermediaries.

As long as deposits function as money, deposits and cash are convertibly used in actual transactions as illustrated in Table 6 below. For buyers and sellers in the non-banking public sector, flow and stock approaches turn out to be indistinguishable in their balance sheets in the sense that cash and deposits are practically booked as the same Cash/Deposits account of assets¹².

Buyers		Sellers	
Debit (Assets)	Credit (Assets)	Debit (Assets)	Credit (Assets)
Commodity (+)	Deposits (-)	Deposits (+)	Commodity (-)
Commodity (+)	Cash (-)	Cash (+)	Commodity (-)

Table 6: Transactions of Non-Banking Sector: Stock Approach

6 Heads and Tails of the Identical Coin

6.1 Gold Standard

Having presented flow and stock approaches of modeling functional-money creation, we are now in a position to compare their behaviors. The comparison is done by expanding the amount of base money step by step. Let us start with the case in which the central bank issues gold certificates, worth of \$200 (unit of this amount could be billion dollars or whatever unit appropriate to the economy in concern), in exchange for the gold it receives from the public; that is, the economy starts with the base money of \$200. This initial situation reflects a historical incident in which goldsmiths and/or bankers kept gold in their vaults for the safety of gold holders and issued gold certificates, which, then, began to circulate as bank notes. Modern banking system has originated accidentally in this way.

In the flow and stock models it is assumed that $\alpha = 0.2$ and $\beta = 0.1$. Then money multiplier becomes $m = \frac{0.2+1}{0.2+0.1} = 4$ and money stock will eventually attain the level of \$800 ($= 4 * 200$), as expected from the equation (12), assuming no vault cash held by banks.

In the left-hand diagram of flow approach in Figure 10, money stock (data) (line 2) is slightly different from money stock (line 3) during an early adjustment

¹²In fact, cash and deposits items in many balance sheets are integrated as an inseparable Cash/Deposits stock.

period, yet both begin to coincide eventually. Reserves at the central bank (line 4) begins to accumulate by nature of flow approach.

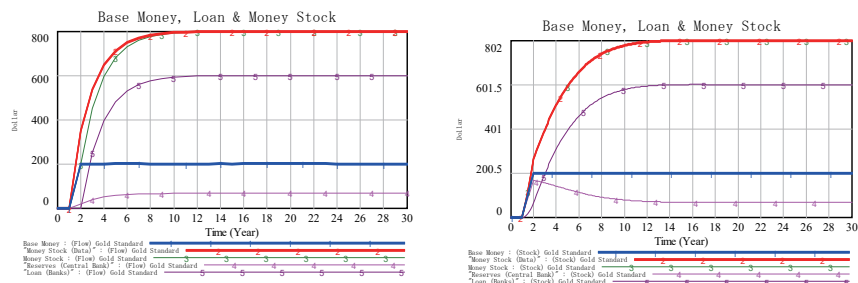

Figure 10: Gold Standard Behaviors: Flow and Stock Approaches

On the other hand in the right-hand diagram of stock approach, both money stock (data) (line 2) and money stock (line 3) coincide from the start and eventually attain the level of \$800. Reserves at the central bank (line 4) jumps in the beginning by nature of stock approach, then begin to decline due to cashing adjustment by the public sector. Yet, base money stays at the same level of \$200 in both flow and stock approaches. Accordingly, except the small differences in the beginning between lines 2 and 3 in the flow approach, both base money and money stock (data) behave identically between flow and stock approaches.

6.2 Discount Loan to Banks

Under the gold standard, the central bank can maximize money stock by reducing required reserve ratio to zero; that is, $\beta = 0$, so that money multiplier increases to $m = \frac{0.2+1}{0.2+0} = 6$, considering that the currency ratio α of the public is out of control for the central bank. Then, money stock can be eventually maximized at the level of \$1,200 ($= 6 * 200$).

What this maximum amount of available money stock under the gold standard meant historically is that as the economy continued to grow, money stock sooner or later became insufficient to meet its increasing demand for money, which eventually resulted in the abandonment of the gold standard in 1930s, and dollar-gold standard in 1972.

To meet the increasing demand for money stock, commercial banks are obliged to borrow from the central bank, which is known as discount loan. In our model it is assumed that the discount loan of \$100 is additionally made to commercial banks at the year $t=6$ as shown by the increase in base money (lines) 1 in both diagrams of Figure 11. How does this increase in base money through discount loan contribute to the increase in money stock?

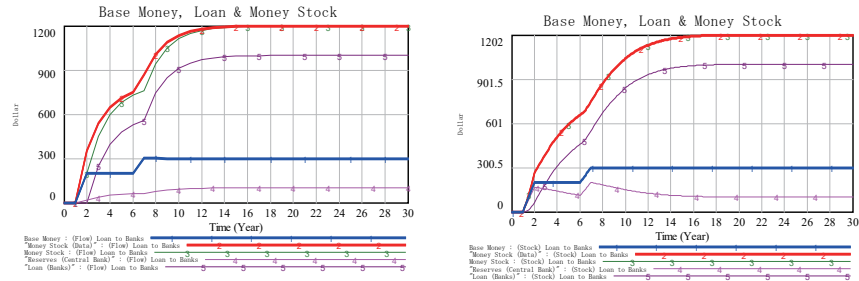

Figure 11: Discount Loans to Banks: Flow and Stock Approaches

As illustrated in the left-hand (flow approach) and right-hand (stock approach) diagrams of Figure 11, the increase in base money by \$100 at the year $t=6$ has eventually increased money stock by \$400 ($=4 \times 100$), totaling to \$1,200 from \$800. Again except the behaviors of reserves, both flow and stock approaches produce similar increases in money stock.

6.3 Loan to Government

As the economy grows, government activities also continues to expand, and the government begins to need more money for its expenditures than its budgetary revenues. To simulate this case, it is assumed that government is obliged to borrow \$100 by issuing securities at the year $t=10$. Does this additional debt by the government increase money supply?

Many people, including economists, incorrectly believe that huge amount of government debt eventually triggers inflation. To cause inflation, however, money stock has to be concurrently increased, which, in turn, needs the increase in base money under the fractional reserve banking system.

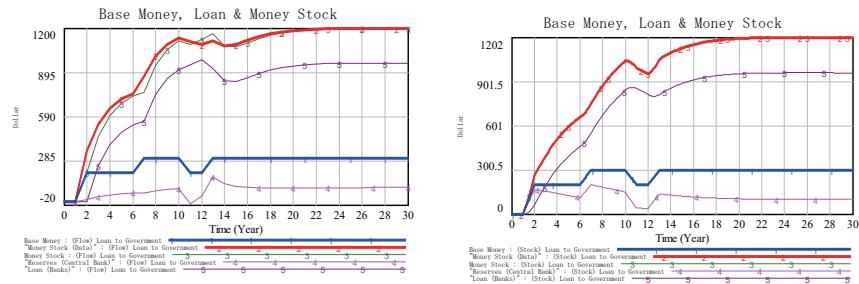

Figure 12: Government Loan: Flow and Stock Approaches

In Figure 12, it is shown that except the period in which government borrows at $t=10$, base money does not change irrespective of the government debt

of \$100. Without the increase in base money, money stock has no reason to increase as well, though flow and stock approaches produce a little bit different adjustment behaviors against the government debt. Money stock will be eventually stabilized at the previous level of \$1,200 as before without increases in money stock.

Open Market Purchase

In order to increase money stock for growing demand for money, the central bank has another policy option to increase its base money; that is, the purchase of government securities through the open market operations (or loans to the government indirectly). It is assumed that the central bank purchases 50% of

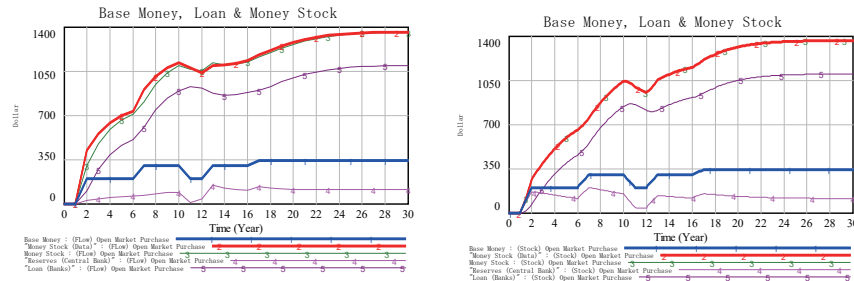

Figure 13: Open Market Purchase: Flow and Stock Approaches

government securities outstanding in the market at the year $t=16$.

This open market purchase increases base money by \$40.3 to its increased level of \$340.3 at the next year $t=17$ as illustrated in both left-hand (flow approach) and right-hand (stock approach) diagrams of Figure 13. The increase in base money, in turn, eventually increases money stock to \$1,362 both in flow and stock approaches.

6.4 Identical Functional-Money Creations

So far we have observed, step by step, how money stocks are increased in response to the increases in base money due to the discount loan to banks and loan to the government (security purchase). Our simulation results indicate that both flow and stock approaches of functional-money creation entail similar behaviors of money creation.

Figure 14 illustrates the flow approach behaviors of base money (left-hand diagram) and money stock (right-hand diagram) under four different situations; gold standard (line 1), discount loan to commercial banks (line 2), loan to the government (line 3) and open market purchase of government securities (line 4).

Figure 15 illustrates the stock approach behaviors of base money and money stock under the same situations as in the flow approach.

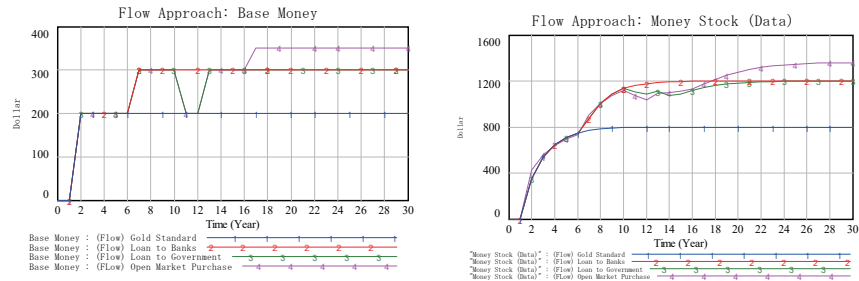

Figure 14: Behaviors of Base Money and Money Stock: Flow Approach

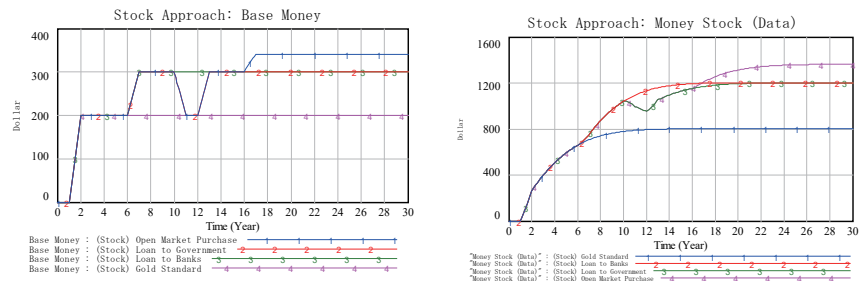

Figure 15: Behaviors of Base Money and Money Stock: Stock Approach

The comparison of these two figures confirms that behaviors of flow and stock approaches are identical, as if they are heads and tails of the identical coin. This is our first result in this paper concerning a century-long dispute among economists on the creation of money.

6.5 Inseparable heads and tails in Banking Practices

If flow and stock approaches are identical, which one of modeling should be used for the analysis of economic behaviors? For the macroeconomic analysis of aggregate banking sector, either approach works well.

At the microeconomic level of individual banks, however, the answer depends on the target sectors of economic analysis. Among non-banking public sectors, producers and non-banking financial institutions are constantly in a state of liquidity deficiency and need to borrow from banks, while consumers tend to make deposits.

Under the circumstances, if consumers are main clients of banks, these banks tend to hold excess reserves, out of which loans are made first to derive arbitrage interest incomes between deposits and loans. Hence, for the analysis of such banking practices, the flow approach of banks (say, heads of the coin) that

masquerade as intermediaries may be appropriate.

If producers and non-banking financial institutions are main clients of banks, the stock approach of functional-money creation (say, tails of the coin) may be appropriate for analyzing their banking practices. These banks make large amount of loans first, then adjust to their reserve requirements later through interbank call money market, etc. Hence, the selection between flow and stock approaches depends on target sector of analysis so long as the analysis objective is at a microeconomic level.

In real banking transactions at the microeconomic level, however, both practices of flow and stock approach coexist and become impractical to distinguish one from another. This coexistence might have confusingly misled economists into either heads or tails camp, or "three main theories of banking" according to the classification of Werner [14]. Under these confusions, bankers who wish to hide away their practice of functional-money (or deposits) creation out of nothing tended laboriously to support flow approach of "banks as intermediaries".

Our ASD-based modeling analysis has successfully revealed the equivalence of flow and stock approaches as the heads and tails of the identical coin. Even so, it's worth drawing attention to the reader that significant differences in banking practices exist at the individual banking level.

7 Instability of Functional-Money Stock

7.1 Liquidity Preferences in Non-Banking Sector

The current debt money system that creates functional-money out of nothing is now fully analyzed. If it works well, it could be the best system because money necessary for our economic activities is created out of nothing or at no cost! On the contrary, it turns out to be a faulty system, as discussed from now on, in the sense that it causes monetary and financial instabilities, followed by booms and busts, economic recessions, unemployment, income inequalities, etc.

Without losing generality, our analysis from now on utilizes the stock approach of functional- money creation. There are several factors under the fractional reserve banking system that cause monetary instabilities in the current system. The first factor we investigate here is fluctuations of currency ratio (α).

Though cash are becoming less and less used as a means of transactions thanks to information technology (particularly in Nordic countries such as Sweden and Finland), bank notes and government coins still play an indispensable means for payments in relatively smaller transactions. In Japan, for example, not only relatively higher currency ratio is observed (about 15% of money stock M_1), but a cyclical demand for bank notes from season to season is reported by the Bank of Japan [8, 2011]. Accordingly, meeting depositor's demand for cash withdrawal becomes one of main services for banks to fulfill. It is indeed their obligations to avoid bank-runs during economic recessions and depressions.

How does the fluctuation of currency ratio affect money stock (data), then? Our analysis in this section is carried out in the above case of discount loans

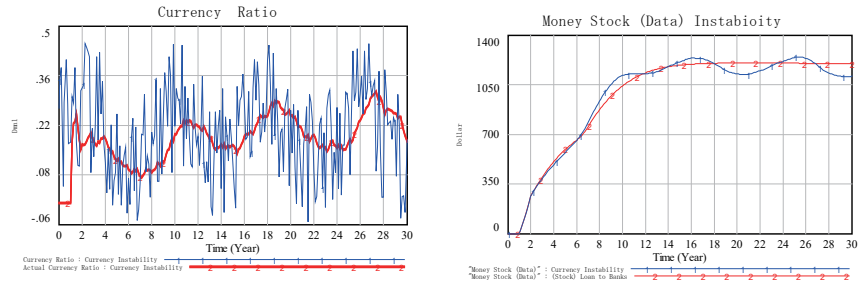

Figure 16: Currency Ratio Fluctuation and Money Stock Instability

of \$100 by the central bank to commercial banks. As an economic background force, Juglar business cycle of 8 years is created by sine function. And the public sector (producers, consumers and non-banking financial institutions) is assumed to react this business cycle by changing their attitudes toward liquidity preferences (that is, currency ratios) according to the Random Normal Distribution of Mean=0 and Standard Deviation=0.2.

Coarse fluctuations of currency ratio caused by this random behaviors are illustrated in the left-hand diagram of Figure 16 (line 1). Yet, behaviors of actual currency ratio (= Currency in Circulation / Deposits (Banks)) are smoothed out as soft business cycle of 8 year (line 2).

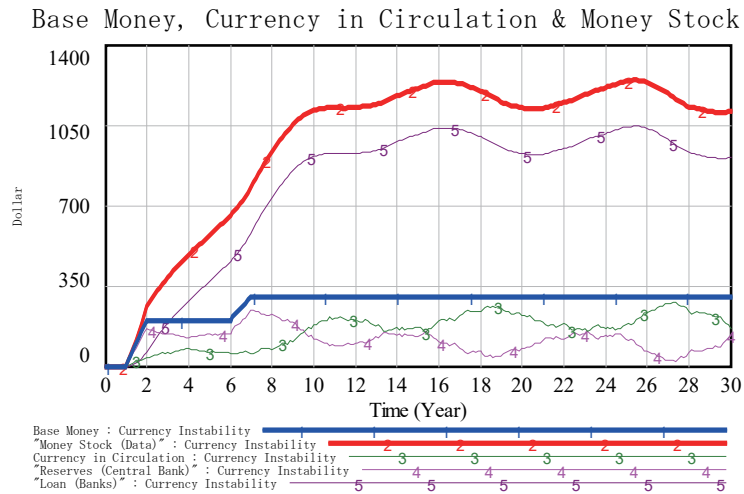

Figure 17: Stable Base Money and Money Stock Instability

Right-hand diagram shows how these fluctuation of currency ratios causes

instability of money stock (line 1) compared with the stable money stock (line 2) when currency ratio is held constant at $\alpha = 0.2$. Figure 17 is the enlarged one together with additional behaviors. Base money (line 1) in the figure is kept stable, though currency in circulation (line 3) fluctuates cyclically. This stable base money vividly contrasts with the cyclical fluctuations of money stock (line 2) and bank loans (line 5). *Stable base money creates unstable money stock* under the fractional reserve banking of debt money system!

7.2 Lending Behaviors of Commercial Banks

Instability of money stock is also caused by lending behaviors of banks. In addition to the same economic case of discount loan of \$100 as above, let us further assume that bankers impatiently want to make more loans out of their maximum loanable fund for a shorter lending period. Specifically we assume that bankers make 60% of loanable fund (instead of 30%) over one year (instead of over 3 years); that is, Lending Ratio = 0.6 and Lending Time = 1 in the model here.

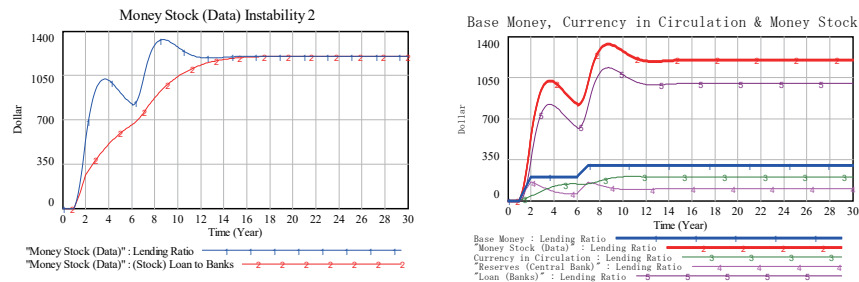

Figure 18: Impatient Lending Behaviors Overshoot Money Stock

Left-hand diagram of Figure 18 illustrates overshoot and fluctuation of money stock (line 1) compared with the stable case (line 2). Right-hand diagram indicates that this overshoot behavior of money stock (line 2) occurs even under the stable base money (line 1) and stable currency in circulation (line 3). In this way, unstable money stock is caused by impatient or short-sighted lending behaviors of bankers.

Amplified Behavior of Combined Ratio Fluctuations

What will happen if capricious attitudes of the public toward liquidity preferences and impatient lending behaviors of bankers are combined in the economy? Figure 19 illustrates these combined effects on the money stock (line 2). Compared with the behaviors of money stock in Figures 17 and 18, money stock fluctuation (line 2) gets amplified irrespective of the wholly stable base money (line 1).

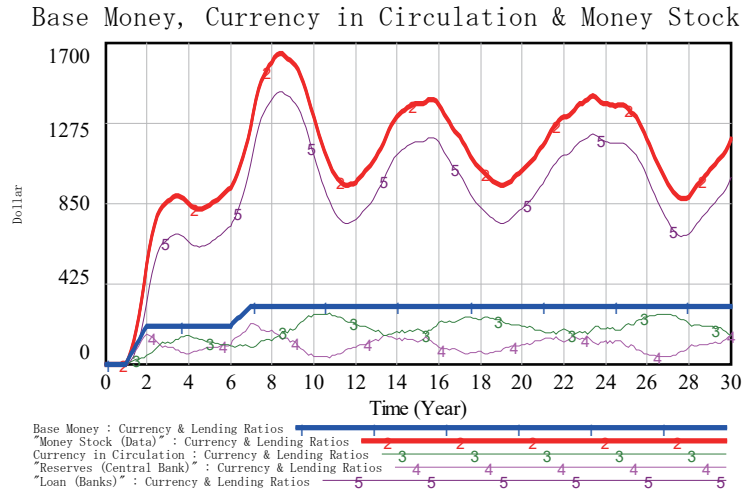

Figure 19: Amplified Instability of Money Stock under Stable Base Money

Notice the scale of figure is changed from 1,400 in Figures 17 and 18 to 1,700. Base money is still stable, yet compound changes in currency and lending ratios trigger wilder instability of money stock. This amplified behavior of the system reminds us of "Bullwhip Effect" in supply chain; that is, roaring production in upper stream caused by relatively stable downstream demand. Even at this stage of investigation, system dynamics researchers would unanimously say that this is another example of *system design failure!*

7.3 Destruction of Functional-Money by Debt Repayments

So far we have focused on the creation of functional-money and money stock. Inversely the same debt money system can destroy money stock instantaneously whenever debts are repaid. In addition to the same economic case of discount loan of \$100 as above, let us further assume that the public sector, mainly producers or corporations, continues to repay 20% of their debts, that is, repayment ratio = 0.2, for two decades, starting at the year $t=10$.

This assumption corresponds to the economic case in Japan in which after the burst of bubbles around mid 1990s many Japanese corporations were forced to repay their debts to escape from the underwater situation of their net assets, caused by the massive depreciation of their financial assets, and restore better shape of their balance sheet. The economic recession triggered by the repayments of debts is called "Balance Sheet Recession" by Richard C. Koo [6, 2009]. Since then Japan has been suffering from the balance sheet recession for almost two decades.

Figure 20 illustrates how bank loans (line 5) and money stock (line 2) can

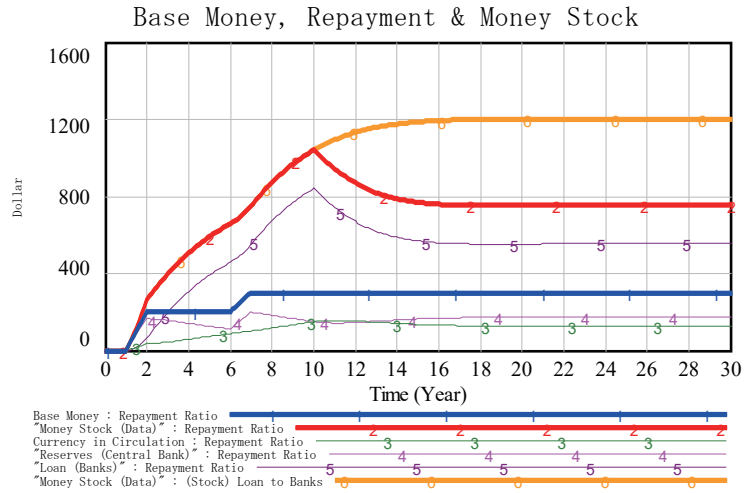

Figure 20: Destruction of Functional-Money by Repayments

be incessantly and concurrently destroyed by repayments. Base money (line 1) as well as currency in circulation (line 3) stays stable, yet money stock gets destroyed. Whenever money stock gets destroyed, economic activities and employment also get destroyed concurrently.

This massive destruction of functional-money is not only a phenomenon confirmed by simulation here, but it really happened during the Great Depression between 1929 and 1933 in the United States, as Irving Fisher described more metaphorically as follows.

This loss, or destruction, of 8 billions of check-book money¹³ has been realized by few and seldom mentioned. There would have been big newspaper headlines if 8 thousand miles out of ever 23 thousand miles of railway had been destroyed. Yet such a disaster would have been a small one compared with the destruction of 8 billions out of 23 billions of our main monetary highway. That destruction of 8 billion dollars of what the public counted on as their money was the chief sinister fact in the depression from which followed the two chief tragedies, unemployment and bankruptcies. Irving Fisher[1, pp. 6 - 7, 1935].

Financial Bubbles and Bursts in Japan

Another historical case of the destruction of bank loans happened in Japan after the bursts of her asset price bubbles around mid 1990s. Japanese bubbles were

¹³That is, the loss of demand deposits between 1929 and 1933.

mainly fueled by functional-money creation by commercial banks to their affiliated nonbanks¹⁴, who further lent those funds to business enterprises (including SMEs) at higher interest rates.

Like the Great Depression in 1929, the asset bubbles in Japanese economy could not hold its breath for a long time. Asset prices (stocks, real estates, lands etc) hit its peak in mid 1990s, followed by the significant collapses. As Figure 21 demonstrates, total bank loans (line 5) in their balance sheet had skyrocketed till mid 1990s, then numerous companies who have borrowed massive amount of functional-money faced with insolvency. Accordingly, they are forced to repay their debts, reducing their loans as illustrated by line 5. This caused prolonged economic recessions and stagnations for two decades long, and Japanese GDP got entirely stagnated (broken line 4).

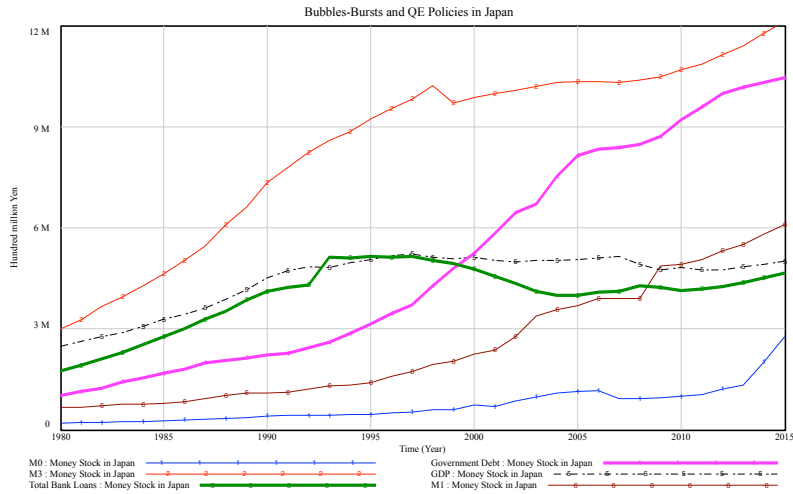

Figure 21: Bubbles-Bursts followed by QE Policies in Japan

Yet, contrary to our explanation so far and historical fact during the Great Depression in 1930s, money stock of M_1 and M_3 in Japan (lines 6 and 2) continued to grow irrespective of the loss of loans. That is, the destruction of bank loans was not followed by the destruction of money stocks. How could it be explained, then? They were counter-balanced first by the massive government deficit, followed by the QE policies (exceptional open market purchases by the Bank of Japan), starting March 2001 through March 2006, then restarting in 2013 as indicated by the increases in base money M_0 (line 1).

¹⁴Nonbanks are private institutions that raise funds by methods other than deposits and deposit-like instruments. They invest funds through loans with interest rates usually higher than that of bank loans. Nonbanks in Japan include finance companies and structured-financing special purpose companies (SPCs) and trusts.

8 Impediment to QE Policies

To understand this abnormality in Japan, let us investigate the expected impact of QE policies on money stock. Recent QE policies introduced in Japan, USA and EU are aimed at increasing money stock through massive purchase of mainly government securities that directly increase base money, with a hope that the increased money stock will eventually stimulate economic activities and GDP. The policy is similar to the open market purchase explained above, and its positive effect is also demonstrated in Figure 13 above.

Yet, in reality all the ongoing QE policies seem to have failed due to the massive destruction of bank loans and the balance sheet recession as discussed above. These failures could be reproduced in Figure 22 by combining Figures 13 and 20.

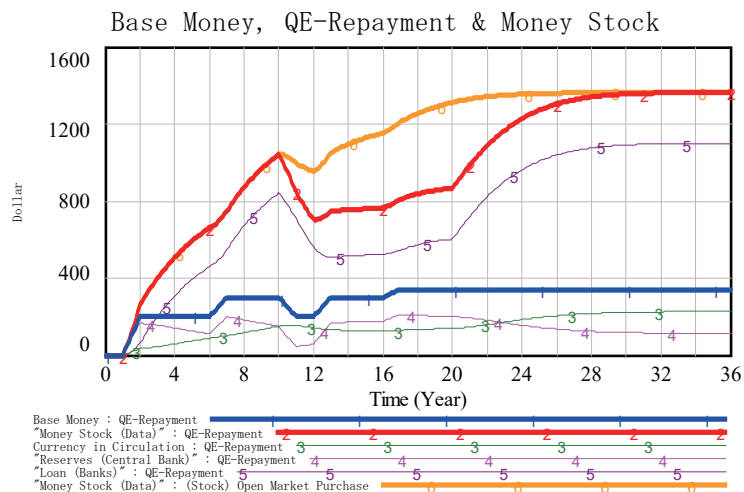

Figure 22: Failures of QE caused by Repayment

In the figure open market purchase of 50% is introduced at $t=16$, which increases base money (line 1) in the following year. Since bank loans (line 5) have been destroyed due to the repayments, money stock (line 2) has also been destroyed. Under the circumstances, the increase in base money fails to increase money stock to the level in which repayments do not exist (line 6). To be worse, monetary authority and government have no direct control over this failure. Apparently, It is caused by the monetary instabilities build in the current debt money system.

In Figure 22 it is assumed that after a decade-long balance sheet recession, the non-banking public sector has completed its repayments, and money stock (line 2) begins to increase to the previous level (line 6). What will happen if, under this recovered situation, currency ratio begins to fluctuate again ?

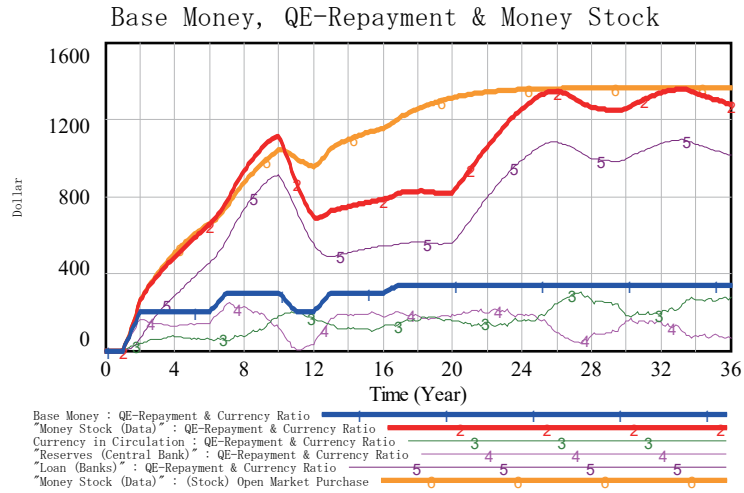

Figure 23: Failures of QE caused by Repayment and Liquidity Fluctuation

Figure 23 demonstrates that this recovery is again hindered by the currency ratio fluctuation or liquidity preferences, and money stock (line 2) becomes cyclical and unstable. To be worse, the fluctuation of liquidity preferences cannot be under direct control of both the central bank and the government. In other words, QE policy is destined to face structural obstruction under the current debt money system and economic conditions behind it.

Failures of QE Policies in Japan

To investigate the actual behaviors of monetary aggregates in Japan by QE policies in relation to base money, let us examine how M_1 and M_3 have been affected by the amount of M_0 . For this purpose, behaviors in Figure 21 are normalized so that all data values become 100 in the year 2000 in Figure 24.

As explained above, QE policy is nothing but the exceptional open market purchases of government securities and other commercial bonds held by banks to increase base money, or more specifically bank reserves. The Bank of Japan introduced QE policy in March, 2001 through March, 2006 as the first trial policy among major economies. As a result, during this period base money M_0 (line 1) increased, which also seemed to have increased demand deposits M_1 (line 6) simultaneously despite the massive destruction of bank loans (line 5). However, as pointed out by Richard Koo [6, 2009], this increase in M_1 was actually caused by the massive injection of government debt (line 2), counterbalancing the destruction of bank loans.

Following the Second Great Depression, the so-called Lehman Shock, in 2008, the Bank of Japan was forced to reintroduce QE policy for the second time in

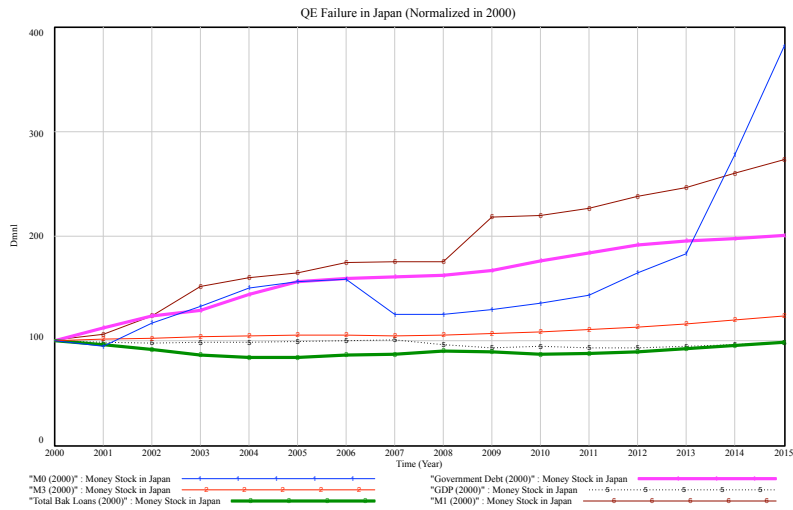

Figure 24: Failures of QE policy in Japan

April of 2013, increasing its base money (reserves) by 131.3 trillion yen through April 2015¹⁵. Accordingly the base money has increased by 150.8 trillion yen during last two years from 149.5 trillion yen to 300.3 trillion yen; almost 4 times increase since 2000 (line 1). Yet, money stock M_1 this time only increased by 57.2 trillion yen from 560.9 trillion yen to 618.1 trillion yen. Money multiplier, which is a ratio between money stock and base money, was 3.75 in 2013. If it would have stayed stable as most QE policy makers had expected, the increase in base money by 150.8 trillion yen could have increased money stock by the amount of 565.5 trillion yen! Yet, it only increased by 57.2 trillion yen, only about 10% increase of the expected amount. If this increase in base money were to be done as helicopter money, it would have increased money stock at least by the same amount of 150.8 trillion yen. Traditional macroeconomic theory has completely failed to explain this failure of QE policies in Japan.

Concurrently QE policies have been heavily applied to the depressed economies of U.S and EU countries as their *last resort* of financial policy to stimulate their economies. Unfortunately, they have also failed as in Japan. The failures of QE policies as "last resort" imply *the failure of system design* of the current debt money system of fractional reserve banking. As an *unprecedented last resort*, the Bank of Japan is further pushed to introduce "negative interest rate policy (NIRP)" on January 29, 2016! For system dynamics researchers, it seems to be an ineffectual struggle for further exacerbating system design failure.

¹⁵Figures used in the argument here is based on [17, 2016], to which the reader is referred for detailed discussions.

9 System Design Failures of Debt Money

Business Model of Banks: Unearned Interest Revenues

Current debt money system of fractional reserve banking is verified in this paper to have built-in system design failures in the sense that it causes monetary instabilities leading to booms and busts, economic recessions, and unemployment, etc. Even recent QE policies that have been expected to save our sinking economies as last resort have also failed.

What is a driving force, then, to cause these system design failures in the current debt money system? It is the incessant motivation of bankers for higher interest revenues as their profits. Business model of bankers is to make loans as large as possible and collect interest revenues from these loans. There is nothing wrong with this business model as corporate business model of maximizing profits.

The problem is that banks can create functional-money almost unlimitedly out of nothing, and derive *unearned* interest revenues as much as possible out of nothing, causing huge amount of income inequality between bankers and non-banking public; that is, between 0.1% and 99.9%. In a sense it is a free-lunch business model in banking sector, enabled by the fractional reserve banking. Bankers' greed is not the point of criticism here. Greed as a driving business force to attain self-interest in our market economy has been justified since Adam Smith wrote "The Wealth of Nations" in 1776, because it is expected that the invisible hand of God will eventually harmonize these selfish and greedy behaviors in the markets towards market equilibrium.

Instead, the problem lies in the current fractional reserve banking system itself that drives greedy business activities into *crazy* bubbles. Once bubbles get started, every investor can profit, because bubbles and increasing financial asset prices create *positive-sum games*. This constitutes a positive feedback loop of bubbles. In other words, fractional reserve banking system has a built-in positive feedback loop to drive bubbles as illustrated in Figure 25. As long as the unearned interest revenues can be obtained out of nothing in this system, no one can stop repeated occurrences of bubbles.

Bubbles always pop. Whenever bubbles get burst, economic recessions start and financial asset prices begin to depreciate. Hence everybody begins to lose their financial assets that are once inflated under bubbles. Positive-sum games now turn into horrifying *negative-sum games* in which all investors lose and public losses continue to accumulate as illustrated in Figure 25. Under the circumstance, corporations are forced to repay their debt, which in turn destroys money stock as discussed above, and shrinks economic activities due to the shortage of liquidity or money stock. That is, balancing feedback loop begins to dominate positive feedback loop.

It is now clear that the driving force of monetary instabilities is the incessant greedy motives to acquire unearned interests out of nothing, tied with bank loans under the current fractional reserve banking system. The source of their unearned interest revenues is nothing but the value added flow of domestic

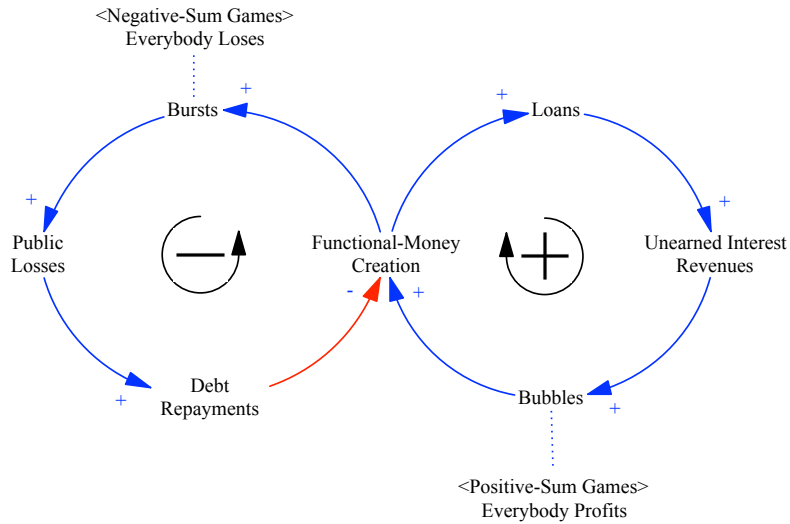

Figure 25: Driving Force of Instability: Unearned Interest Revenues

products or GDP; that is, this is *zero-sum games* of GDP in which bankers are destined to win and non-banking public are to lose. This becomes the root cause of income inequality between bankers and non-banking public; that is, between 0.1% and 99.9%.

Can We Re-design a Failure System?

If airplane crashes occur repeatedly, engineers will try to figure out whether these are caused by human errors of pilots or system design failures. When crashes are identified as being caused by system design errors, engineers will be forced to draw new system design of airplanes. Thanks to their repeated efforts of re-design, we have now acquired the safest airplane system in human history.

In a similar fashion, monetary instabilities discussed so far are identified as system design failures of fractional reserve banking, not human errors of greedy bankers. Faced with the on-going financial crises and accumulating government debts triggered by the instability of the current debt money system, economists are now, like engineers of airplanes, obliged to re-design our falling monetary and economic system. Can they re-design it?

10 Designing the Alternative Monetary System

10.1 A Proposal of 100% Reserve by Irving Fisher, etc.

The Great Depression in 1929 was the first major economic disaster caused by the system design failures of the debt money system. Faced with this design failure, eight economists at the University of Chicago¹⁶ proposed an alternative system design called "The Chicago Plan for Banking Reform" in 1933 [9]. The plan was, then, vehemently carried on by Irving Fisher, Yale University [1, 1935] and his group of five economists¹⁷ as "A PROGRAM FOR MONETARY REFORM" in [2, 1939].

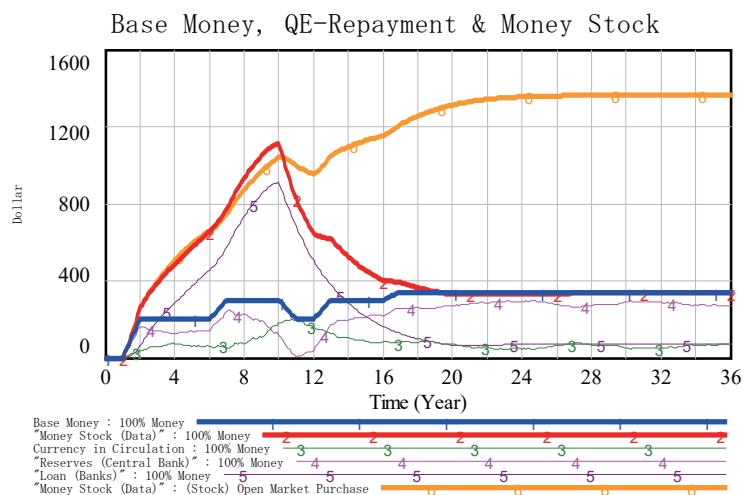

Figure 26: 100% Reserve at t=10

Their alternative system design was to introduce 100% required reserve ratio for demand deposits. Let us investigate how this full reserve system works. Whenever 100% reserve ratio is applied to a recessionary and unstable economic situation presented in Figure 23, its monetary behaviors get, all of sudden, transformed into the stable behaviors as illustrated in Figure 26.

Instability of money stock (line 2) illustrated in Figure 23 is now perfectly subdued by the introduction of this full reserve so that base money (line 1)

¹⁶They are; G.V. Cox, Aaron Director, Paul Douglas, A.G. Hart, F.H. Knight, L.W. Mints, Henry Schulz, and H.C. Simons. Their proposal was handed over, through Henry A. Wallace, Secretary of Agriculture, to the President Franklin D. Roosevelt on March 16, 1933. Unfortunately it failed to be implemented. Instead, less restrictive Banking Act of 1933 to bankers, known as Glass-Steagal Act was legalized on June 16, 1933, by FDR. See [9, 1995]. The Act was repealed in 1999 by President Bill Clinton.

¹⁷They are; Paul H. Douglas, University of Chicago; Frank D. Graham, Princeton University; Earl J. Hamilton, Duke University; Willford I. King, New York University; and Charles R. Whittlesey, Princeton University.

becomes equal to money stock (line 2). Theoretically this can be easily confirmed as follows. When $\beta = 1$, we have $m = 1$ from the equation (11) so that, assuming no vault cash held by banks, we have

$$\text{Money Stock} = m * \text{High-Powered Money} = \text{Base Money} \quad (15)$$

Graphically, money multiplier (line 1) can be confirmed to converge to the value one as illustrated in Figure 27. Money convertibility coefficient (line 2) can be also demonstrated to converge to the value one, which implies that under the 100% reserve money stock can be fully convertible to legal tender.

Under the full reserve system, functional-money disappears completely from the circulation and money stock becomes equal to legal tender (that is, base money). Accordingly, monetary stability is completely restored and money stock never gets affected by the changes in currency ratio and lending ratio, as well as repayment of loans.

Our model has confirmed what Irving Fisher had proudly proclaimed:

I have come to believe that that plan, properly worked out and applied, is incomparably the best proposal ever offered for speedily and permanently solving the problem of depressions; for it would *remove the chief cause of both booms and depressions*, namely, the instability of demand deposits, tied as they are now, to bank loans. Irving Fisher [1, p. xviii, 1935] (*italic emphasis is by this authors*).

This is the alternative system design, known as the Chicago Plan, proposed by the courageous American economists such as Irving Fisher, etc. in 1930, and later by Milton Friedman [3, 1960].

10.2 Public Money System

A mere introduction of full reserve system is, it turned out, not enough to sustain the on-going economic activities, because money stock gets reduced from the previous level (line 6) to the base money level (line 1) as demonstrated in Figure 26. This shortage of money stock can be easily overcome by newly issuing public money and putting it into circulation.

Who should create public money, then, in place of the privately-owned central bank? Its issuer has to be a politically independent public organization from the influences of government and vested interest groups, and at the same time be the one under the publicly elected legislative management such as Congress,

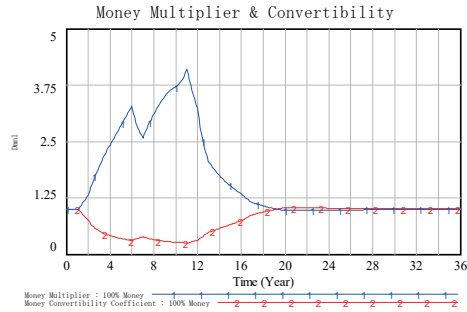

Figure 27: Money Multiplier and Convertibility Coefficient under 100% Reserve

Parliament and Diet. Such an organization is called the *Public Money Administration* (PMA) in Yamaguchi [15, 2013]¹⁸

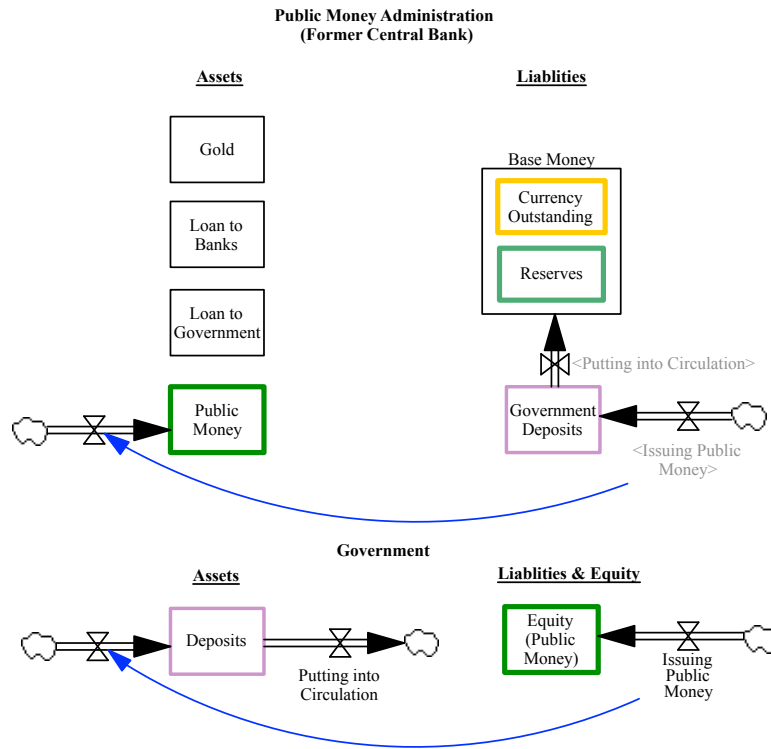

Figure 28: Public Money into Circulation

Figure 28 illustrates how *public money* is being created by the public money administration (former central bank) and put into government deposits account. Public money thus created simultaneously constitutes government equity as well as the assets of the PMA. Now the government gets ready to spend it through its public policies. Some examples of such public money expenditure policies are as follows.

- Public investment in education and research (tuition-free higher education etc.) as human and future investment.

¹⁸Chapter 15 of his book compares system structures and behaviors of debt money and public money systems, and the next chapter 16 presents a generic transition process from the debt money system to the *public money* system. The specific transition process in Japan is proposed in [16, 2015].

- Investment for constructing 21st century infrastructures such as IT network, green energies, and green transportation.
- Universal medical and healthcare program and other social welfare programs.

To make this alternative system design workable by avoiding political pressures of printing more money and causing inflation, the following two conditions have to be strictly met.

- C1. The public money administration plays a role of *supply side* of public money, while the government (dept. of treasury or ministry of finance, etc.) plays a role of *demand side*. The amount of public money is determined by the interplay of demand and supply sides.
- C2. Transparency on the decision process of public money issuance has to be guaranteed to the public.

Through these strict processes, it is assumed in our model here that public money of \$200 is newly issued at $t=18$ for 5 years, totaling the input of \$1,000. In this way, the original level of money stock (line 6) is restored as illustrated in Figure 29. If further money stock is needed for the expanded economic activities,

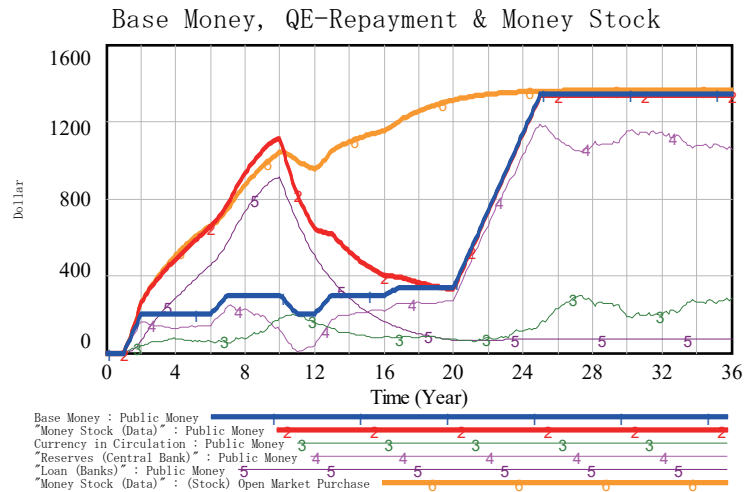

Figure 29: Public Money Put into Circulation at $t=18$ for 5 years

surely more public money is put into circulation through the above-mentioned issuance processes.

10.3 Government Debt Liquidation as a By-Product

Almost all OECD countries are currently suffering from accumulated government debts. Government debts have been increased through fiscal policy to

save the rigged economies caused by the system design failures. Accordingly, if the alternative system design can attain monetary stability, it should also be able to solve debt problem. Indeed, Fisher argued that 100% reserve can reduce government debt as follows:

(17) (b) As already noted, a *by-product* of the 100% reserve system would be that *it would enable the Government gradually to reduce its debt*, through purchases of Government bonds by the Monetary Authority as new money was needed to take care of expanding business. Under the fractional reserve system any attempt to pay off the Government debt, whether by decreasing Government expenditures or by increasing taxation, threatens to bring about deflation and depression. Irving Fisher [2, 1939] (italic emphasis is by this authors).

It is already noted in 1930s that both austerity and tax increase policies, causing deflation and depression, would not work to reduce the government debt as well. Instead, it is pointed out that the 100% reserve system enables its deduction as its "by-product".

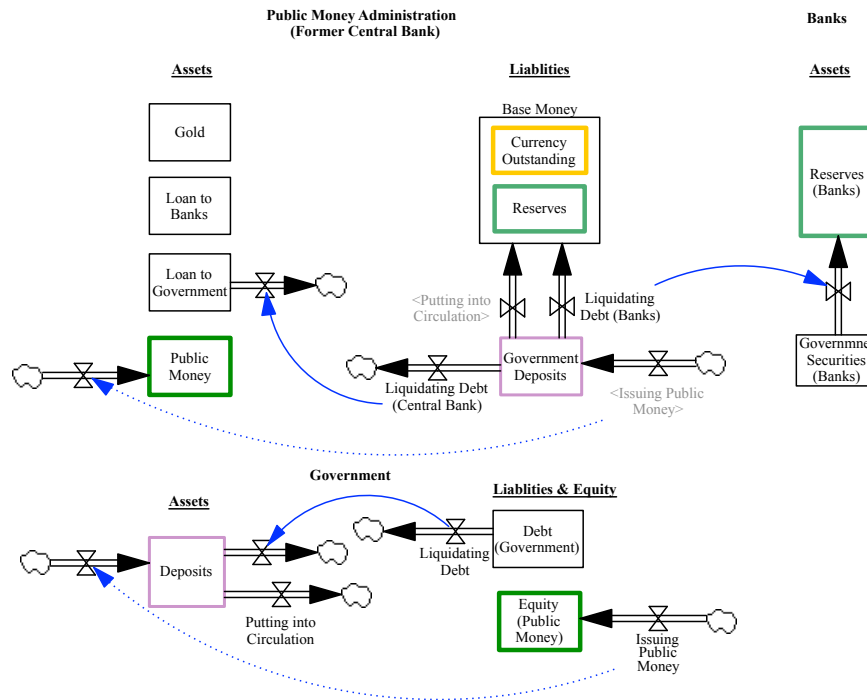

Figure 30: Framework of Debt Liquidation Model

Let us investigate if this assertion of debt liquidation works as a by-product of the full reserve system. Figure 30 provides our simplified modeling framework for liquidating debt. First, government securities held by the former central bank are redeemed out of government deposits directly. Second, government securities held by commercial banks are purchased at book values by the public money administration, and sales revenues of the banks are used to secure their 100% reserves of deposits. Third, government securities held by the public are purchased by the government through transactions via government deposits and bank reserves at the public money administration and public deposits at banks¹⁹.

Such security purchases in turn save plausible risks of banks and the public that may be incurred by the enormous depreciation of security values in case of financial crises and economic recessions. In this sense, the alternative system design additionally becomes a saver or a white knight for troubled banks as well as the public.

Let us assume in our model that debt liquidation under public money gets started at $t=20$ with a debt repayment period of 6 years. Figure 31 shows how government debt (line 1) are gradually liquidated. More specifically, debts held by the former central bank (line 2), by the banks (line 3) and by the public (line 4) are gradually liquidated²⁰.

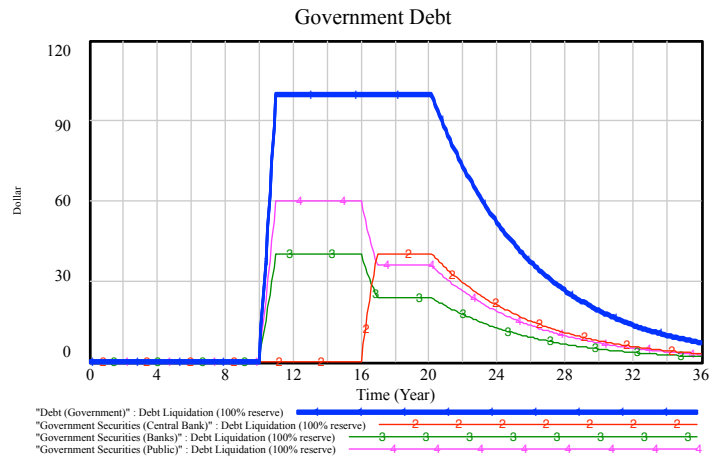

Figure 31: Liquidating Debt

Through this debt liquidation base money increases by $\Delta M_0 = \$55.55$, which is used to liquidate the government securities held by the former central bank. Left-hand diagram of Figure 32 shows that the increase in public money stock through this debt liquidation, starting at $t=20$, is $\Delta M = \$47.6$. Base money

¹⁹This transaction is not illustrated in the simplified Figure 30 .

²⁰Debt liquidation issues are fully discussed in Chapters 12 and 13 of the book [15, 2013].

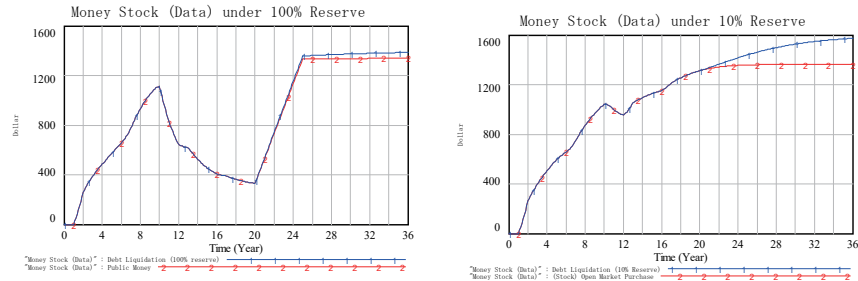

Figure 32: Debt Liquidation under Full Reserve and 10% Reserves

and money stock will be increased by the same amount eventually when debt is completely liquidated.

Government debt liquidation could also be carried out solely by issuing public money under the current fractional reserve system (10% here). Right-hand diagram of Figure 32 shows that the increase in money stock for this debt liquidation, starting at $t=20$, is $\Delta M = \$211.89$ due to the money multiplier effect. This forced liquidation, though it might work only to reduce government debt, will surely cause hyper-inflation. This gives a serious warning to those who *solely* propose government-issued money without introducing 100% reserve system. That implies that debt liquidation can be carried out most effectively under the Public Money System without causing inflation. Concurrently, as mentioned above, it could also be a white knight to the troubled banks and the public.

10.4 Banks as Genuine Intermediaries

Genuine Business Model of Banks

(1) Service Charges Under the 100% reserve requirement, commercial banks are obliged to fully hold customers' deposits. In consequence, non-banking public sector can safely use their deposits anytime as legal tender for their transactions and economic activities. On the other hand, depositors have to pay service charges to the banks in exchange for these transaction services, like the present-day ATM service charges. These service charges in turn become stable source of earned income to the banks. In this way a robust and stable financial foundation will be established for the banking management.

As a by-product, banks no longer need to borrow or lend in the inter-bank money market. Inter-bank rate will be no longer applicable for borrowing or lending excess reserves one another. In this sense, the PMA (former central bank) will be free from complex market operations conducted daily under the current debt money system.

(2) Earned Interest Income If deposits are fully obliged to be kept at banks,

how can the banks find extra money for loans? Loanable funds for banks come from three sources: their own capital, repaid amount of loans, and time deposits. Among these, time deposits will be a main source of loanable funds. Time deposits are nothing but the extra amount of deposits that are not needed for daily and short-term transactions so that they are saved to the time deposits account.

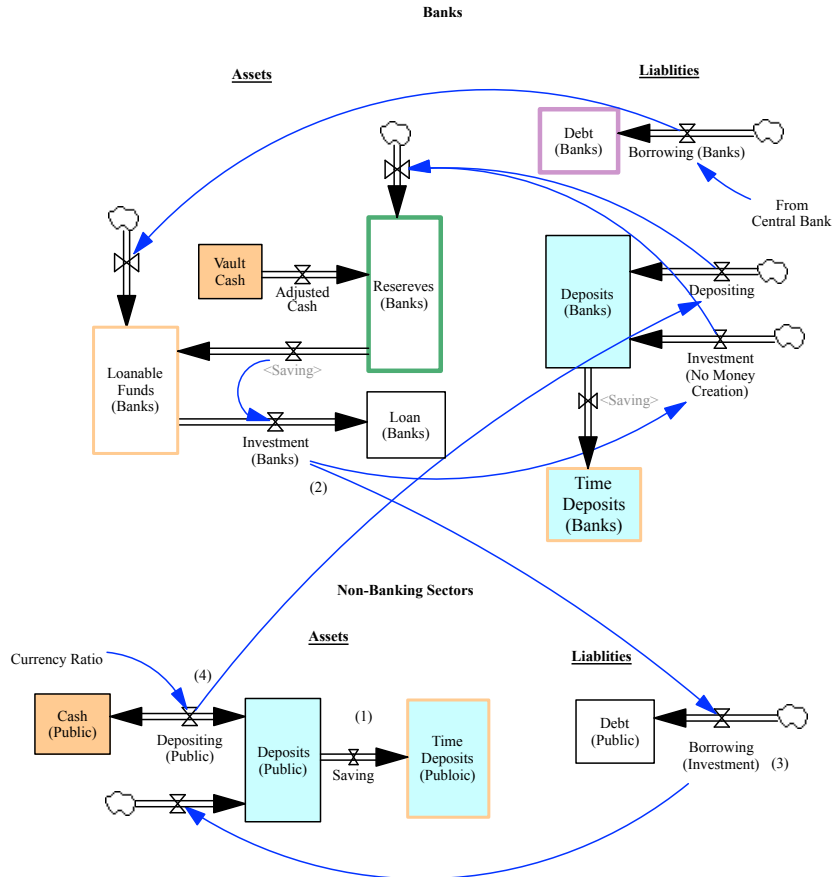

Figure 33: Public Money: Banks as Genuine Intermediaries

In Figure 33, this process is illustrated as saving by non-banking sectors, numbered (1), from their deposits to time deposits, and simultaneously the same amount of transfer takes place at banks. Banks are no longer obliged to keep this amount of saving, which is, then, moved to their loanable funds from reserves. Banks now try to make loans as investment, numbered (2), out of their loanable funds, which becomes debts by non-banking sector, numbered (3), as

well as their deposits. Deposits at banks increases by the same amount, as well as their reserves. In this way loan by banks out of loanable funds is balanced with their time deposits.

With the disappearance of inter-bank rate, commercial banks are now allowed to set interest rate freely by themselves against the loans they make. Accordingly, they become competitive one another by offering higher interest rate for saving, and lower interest for investment loans. Yet, banks are no longer able to create functional-money at all, and become in this sense *genuine intermediaries*. Hence, their source of loans are constantly limited to the available loanable fund, which is now legal tender.

Under such circumstances, bubbles and bursts can no longer occur, and existing financial markets are constrained to real *zero-sum games*; that is, losers and winners coexist. This implies that existing financial bonds and securities are no longer attractive to the banks as a whole. And loanable funds tend to be invested to the *real economy* in which positive interest revenues are obtained for banks as a whole so long as the economy continues to grow.

In this way interests rates are competitively determined in the public money market according to the available amount of saving and investment in the economy. Interest revenues thus obtained through arbitrage or spread of lending and borrowing interest rates become truly their own *earned* income for their efforts to provide investment banking services. Interest revenues, in this sense, are no longer *unearned* income out of nothing.

It is true that investment, whether real or financial, has been risky economic activities through history. Accordingly, to avoid investment risks, earned interest income by banks from investment may be shared among banks and time deposits savers. This risk-sharing system has been historically developed as "participatory banking" system under Islamic banking practices, and "mutual social financing" system known as *Tanomoshi-kou* in Japan since 12th century.

Conclusion

We have started this paper by defining money as legal tender according to the definition by the Greek philosopher Aristotle. Under the current debt money system legal tender is created by the privately-owned central bank as base money. Commercial banks then create deposits as functional-money out of nothing under the fractional reserve banking. Deposits thus created function as legal tender so long as they are accepted for transactions.

Concerning this money creation process, two or three different theories have been presented in the history of economics. They are called flow and stock approaches in this paper according to the accounting system dynamics modeling methods. As the first research result of this paper, it is shown that both approaches are identical as if they are heads and tails of the same coin, ending a century-long dispute among economists on the creation of money.

Secondly, it is demonstrated that the current debt money system of fractional reserve banking entails monetary instabilities in the sense that booms

and busts are repeatedly caused, followed by inflation, deflation, economic recessions, unemployment, income inequalities, etc. Moreover, recent QE policies to overcome these instabilities are also shown to have failed. As an exemplifying case, failures of QE policies in Japan is explored in detail. With these observations in mind, it is concluded that the current debt money system entails system design failures.

Faced with the Great Depression in 1929 as a serious case of system design failure, thirdly, a handful courageous American economists proposed the alternative system design of monetary reform called the Chicago Plan in 1930s. Its nucleus was the introduction of 100% required reserves in place of the fractional reserve banking system. Our SD model of stock approach confirmed that under the full reserve system monetary stability is fully attained, eliminating causes of booms and depressions. As a by-product, government debts are also shown to be gradually liquidated.

Modern version of this alternative system is introduced as the *public money system*, under which newly established "public money administration" is solely allowed to issue public money for sustaining monetary stability, economic growth and social welfare.

References

- [1] Irving Fisher. *100% Money*. The City Printing Company, New Haven, third edition, 1945. First edition (1935) available through ThaiSunset Publications, 2011.
- [2] Irving Fisher, Paul Douglas, Frank D. Graham, Earl J. Hamilton, Willford I. King, and Charles R. Whittlesey. A program for monetary reform (mimeograph), July, 1939. Included in the Editor's Appendix to "100% Money by Irving Fisher", ThaiSunset Publications, 2011.
- [3] Milton Friedman. *A Program For Monetary Stability*. Fordham University Press, New York, 1960, 1992.
- [4] Zoltan Jakab and Michael Kumhof. Banks are not intermediaries of loanable funds - and why this matters. Working Paper No. 529, Bank of England, May 2015.
- [5] John Maynard Keynes. *The General Theory of Employment, Interest, and Money*. Harcourt Inc., London, New York, San Diego, 1964.
- [6] Richard C. Koo. *The Holy Grail of Macroeconomics – Lessons From Japan's Great Recession*. John Wiley & Sons (Asia) Pte. Ltd., Singapore, 2009.
- [7] Amar Radia Michael Mcleay and Ryland Thomas. Money creation in the modern economy. Quarterly bulletin, Bank of England, 2014, Q1.
- [8] Bank of Japan. Institute for Monetary and Economic Studies. *Functions and Operations of the Bank of Japan (in Japanese)*. YUHIKAKU, 2011.

- [9] Ronnie J. Phillips. *The Chicago Plan & New Deal Banking Reform*. M.E. Sharpe, Inc., London, New York, 1995.
- [10] Jannie Rossouw. Private shareholding and public interest: An analysis of an eclectic group of central banks. Working paper 457, Economic Research Southern Africa, 2014.
- [11] Michael Schemmann. Accounting standards — request for reconsideration: Accounting perversion in bank financial statements. Technical report, [www.iicpa.com/articles/Open letter accounting perversion.pdf](http://www.iicpa.com/articles/Open%20letter%20accounting%20perversion.pdf), 1st May 2013.
- [12] Masaaki Shirakawa. *Modern Monetary Policy in Theory and Practice: Central Banking and Financial Markets (in Japanese)*. Nihon Keizai Shinbun, 2008.
- [13] Adair Turner. Debt, money, and mephistopheles – how do we get out of this mess? *Occasional Paper, Group of Thirty, Washington, D.C.*, (87), May 2013.
- [14] Richard A. Werner. A lost century in economics: Three theories of banking and the conclusive evidence. *International Review of Financial Analysis (ELSVIER)*, page 19, 2015.
- [15] Kaoru Yamaguchi. *Money and Macroeconomic Dynamics – Accounting System Dynamics Approach*. Japan Futures Research Center, Awaji Island, 2013.
- [16] Kaoru Yamaguchi. *Public Money – Modern Version of the Chicago Plan that Liquidates Government Debt (in Japanese)*. Toyo Keizai Shinpo-sha, Tokyo, Japan, 2015.
- [17] Kaoru Yamaguchi and Yokei Yamaguchi. Asd macroeconomic model of japan on the flow of funds and national accounts –report on its early stage development. *Proceedings of the 33rd International Conference of the System Dynamics Society, Cambridge, Massachusetts, USA*, July 2015.
- [18] Stephen Zarlenga. *The Lost Science of Money: The Mythology of Money - the Story of Power*. American Monetary Institute, New York, 2002.