

## Appendix A

Table 1: Genetic programming parameters used in all experiments

Objective	Find the underlying differential equations for system dynamics model given the observations of system stocks.
Terminal set	Case dependent
Functional set	Case dependent
Raw fitness	Complexity invariant distance (Batista, Wang et al. 2011) between system observation and the simulated output generated from each individual. The less fitness value the better the solution.
Adjusted fitness	$\frac{1}{1+raw\_fitness}$ , this fitness will be used instead of the raw fitness because it is bounded with [0,1]. The large fitness value the better the solution.
Population size	50 – 1000
Generations	50
Crossover rate	0.9
Reproduction rate	0.08
Mutation rate	0.02
Crossover internal probability	0.9
Mutation probability for each node	0.05
Selection method	Binary tournament selection
Initial population generation method	Ramped half and half
Initial maximum tree depth	2-6
Maximum tree depth	17
Crossover method	Subtree crossover
Mutation method	Subtree mutation

## Appendix B

In this appendix the GP parameters for each case is shown in the tables in addition to the best solution structure found compared with the actual solution, the figures shows how the fitness value is changing for both population size and generations.

Fitness over population figures are showing how the best, worst, average and average al last generation are changing with increasing in the population size. The fitness value for each population size is averaged over all 10 runs of the GP for each type of fitness. For the figures of fitness values that are changing over generations are also averaged over all the 10 runs of the GP.

The best fitness value for each run is the best fitness value over all generations, the worst fitness value is the worst fitness value over all generations, the average fitness is the average over all generations and another average is just calculated for the last generation.

### Case study 1 GP configurations and fitness figures

#### With full information conditions

Terminal set	{ MBA, random_constant(0,1), random_constant(1000, 10000) }
Functional set	{+, *, /, -}
Population size	50 – 500
Best solution structure	$(0.987518 + 4929.26) - ((0.44516 - 0.357147) + (MBA * 0.443695))$
Best solution structure simplified	$(4930.24 - 0.44 MBA)$
Target equations structure	$(5000 - 0.45 MBA)$
Raw fitness	13.1465
Adjusted Fitness	0.070689
Tree depth	3
Population found in	350
Run found in	1
Generation found in	5

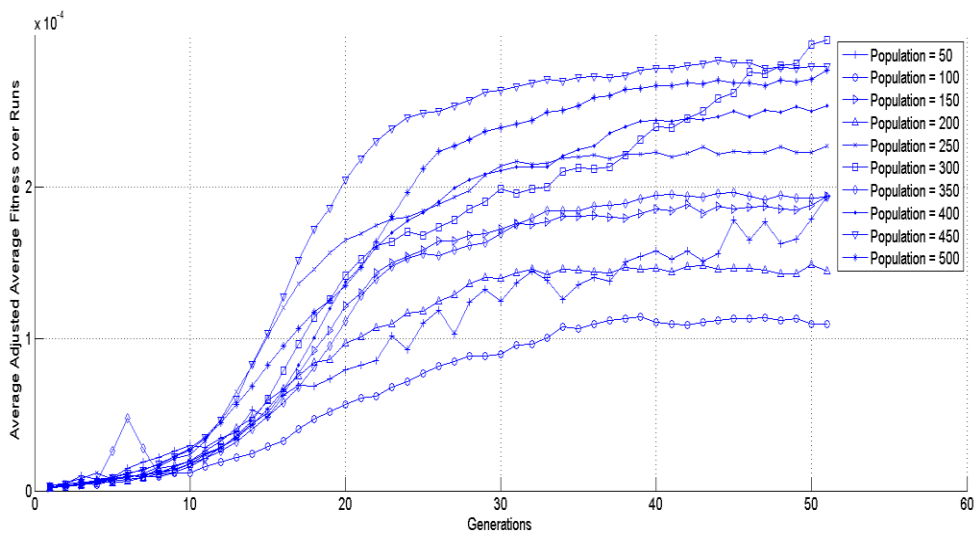
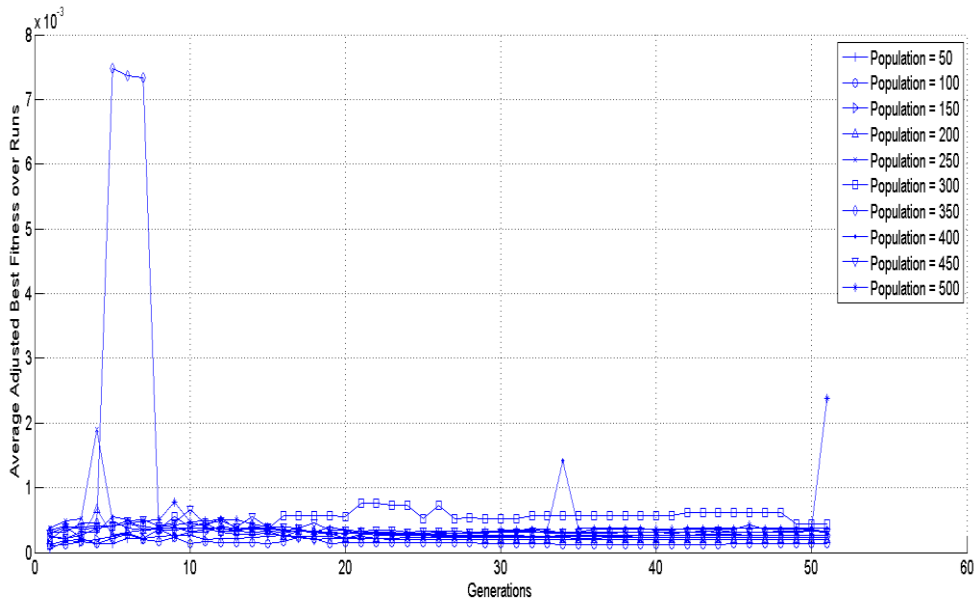
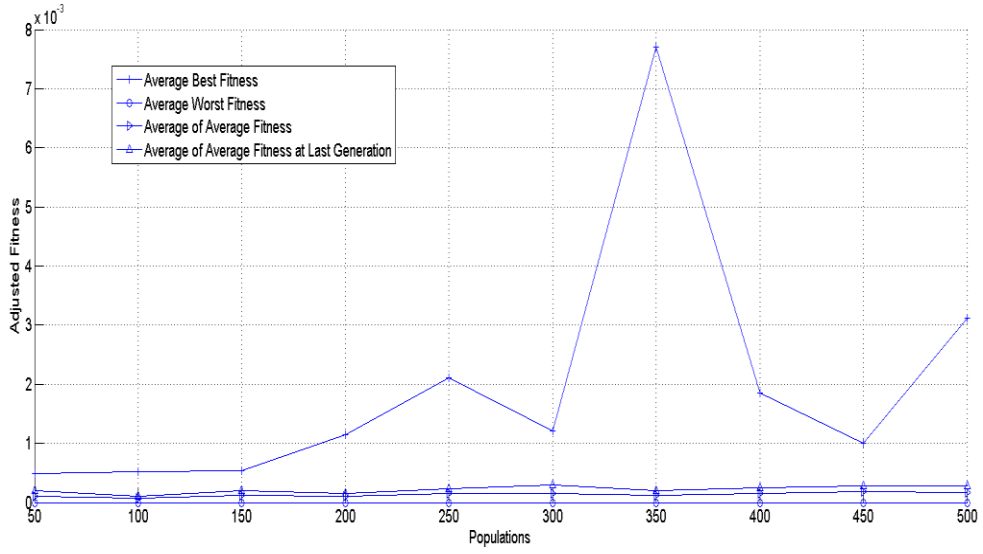

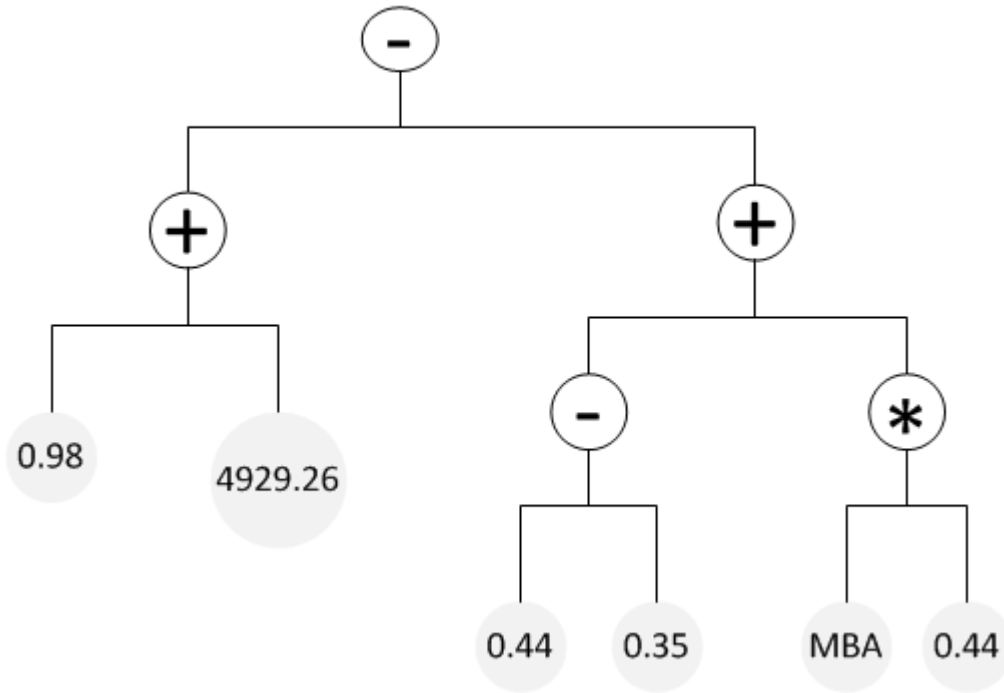

**With partial information conditions**

Terminal set	{ MBA, random_constant(0,1),}
Functional set	{+, *, /, -, max, min, sqrt, log, abs, pow, exp}
Population size	50 – 1000
Best solution structure	((exp(0.595917) / 0.0213013) - (exp(((0.2948 * 0.187378) * sqrt(X))) * (min(log(X),max(0.428894,X)) * exp(log(0.0134583)))))
Best solution structure simplified	$85.19 - \exp^{0.05 * \sqrt[2]{MBA}} * 0.013 * \min(MBA, \max(0.42, MBA))$
Target equations structure	(5000 – 0.45 MBA)
Raw fitness	7815.09
Adjusted Fitness	0.000127941
Tree depth	5
Population found in	750
Run found in	9
Generation found in	10

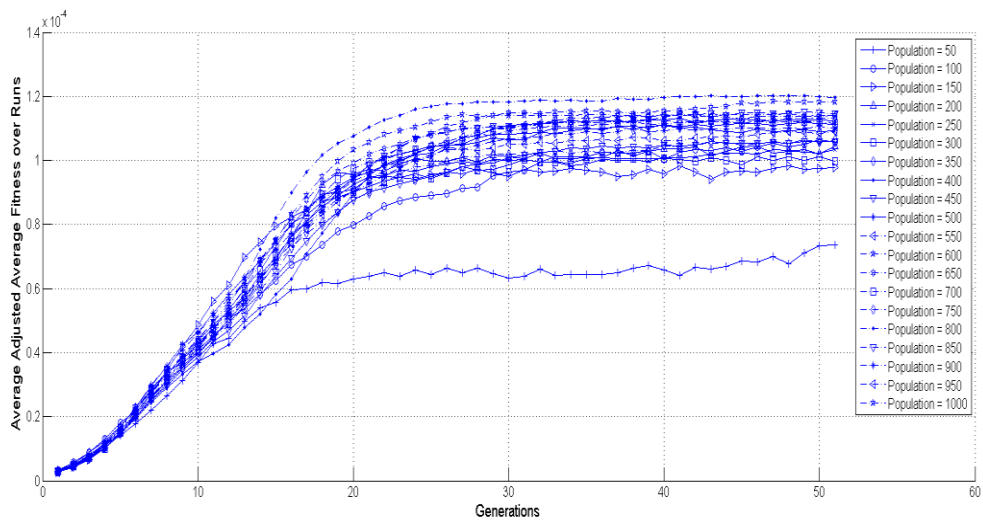
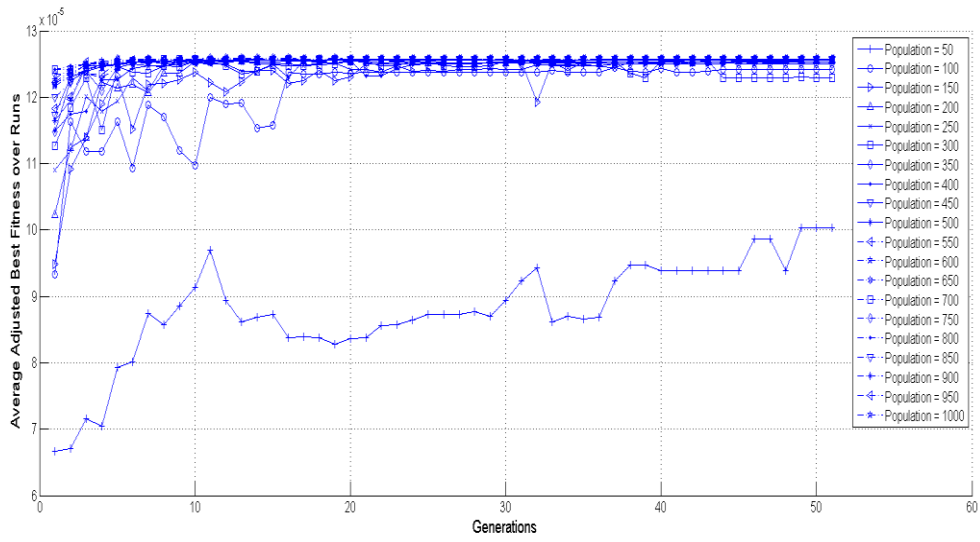
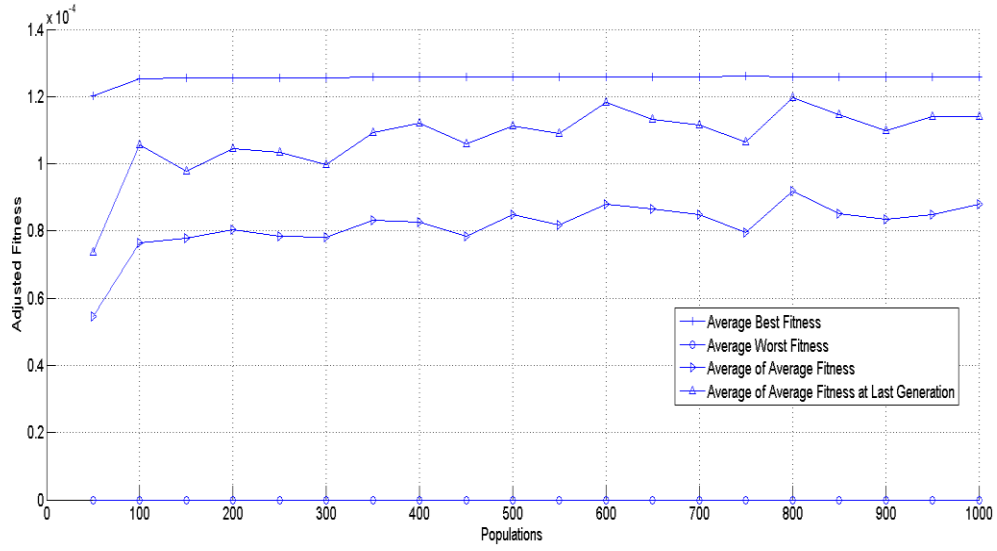

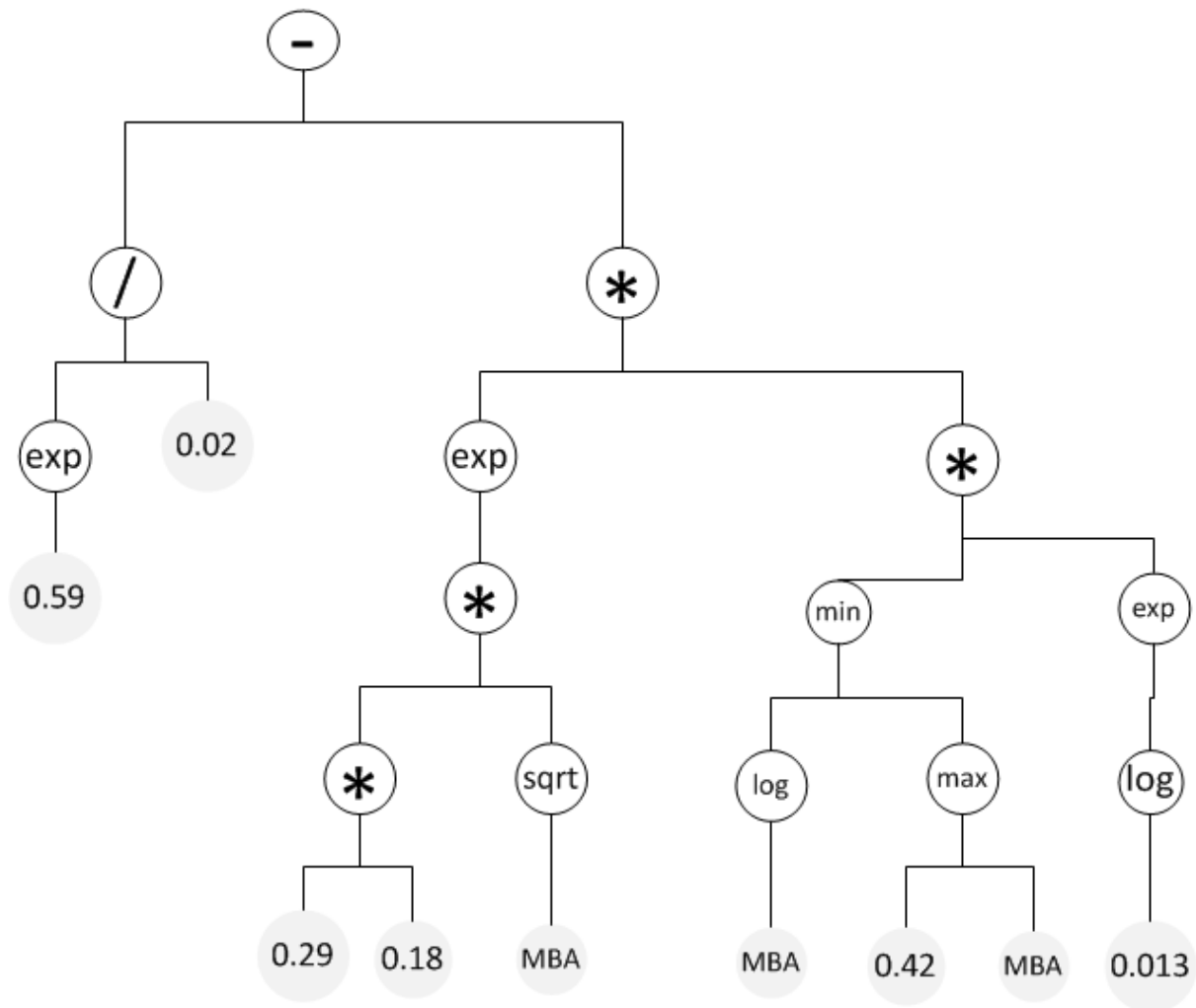

## Case study 2 GP configurations and fitness figures

### With full information conditions

Terminal set	{ HP, SP random_constant(0,1), random_constant(1, 20) }
Functional set	{+, *, /, -}
Population size	50 – 1000
Best solution structure	$(0.207001 - ((HP / SP) + ((14.5965 + 0.56308) - (((0.148163 * SP) * (SP / HP)) - 1.67841))))$  $((((HP / SP) + ((14.5965 + 0.56308) - (((0.148163 * SP) * (SP / HP)) - 1.67841)))) - 1.67841)$

	$(SP) * (SP / HP)) - 1.67841))) + 0.207001)$
Best solution structure simplified	$0.14 * \frac{SP^2}{HP} - \frac{HP}{SP} - 13.27$ $\frac{HP}{SP} - 0.14 * \frac{SP^2}{HP} + 17.045$
Target equations structure	$\left( \frac{SP}{0.5} - \frac{5 * HP * SP}{SP + HP} \right)$ $\left( \frac{5 * HP * SP}{SP + HP} - \frac{SP}{0.5} \right)$
Raw fitness	154.676
Adjusted Fitness	0.00642361
Tree depth	6
Population found in	950
Run found in	6
Generation found in	43

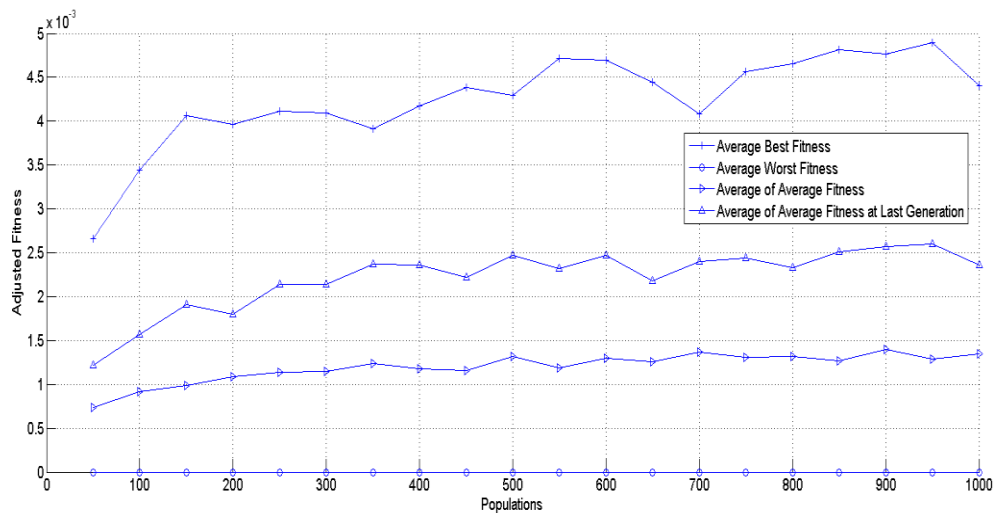

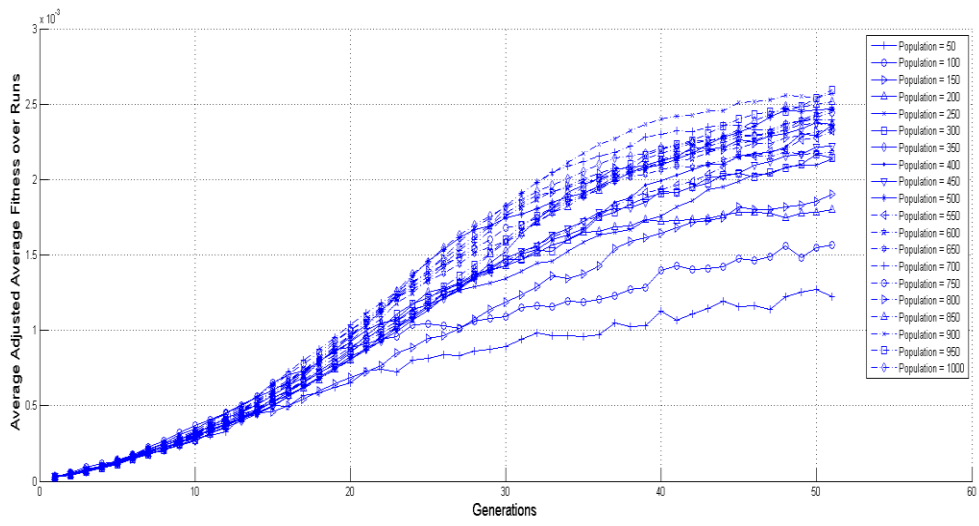
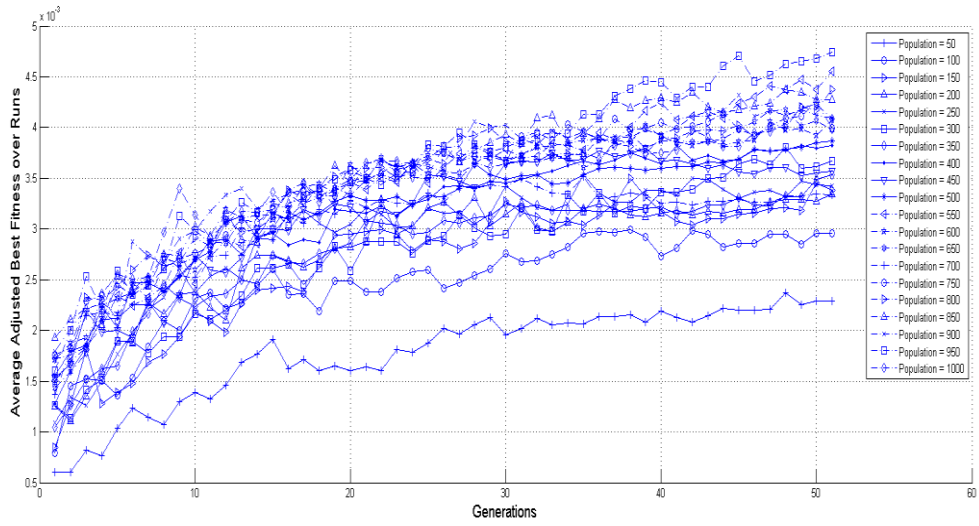



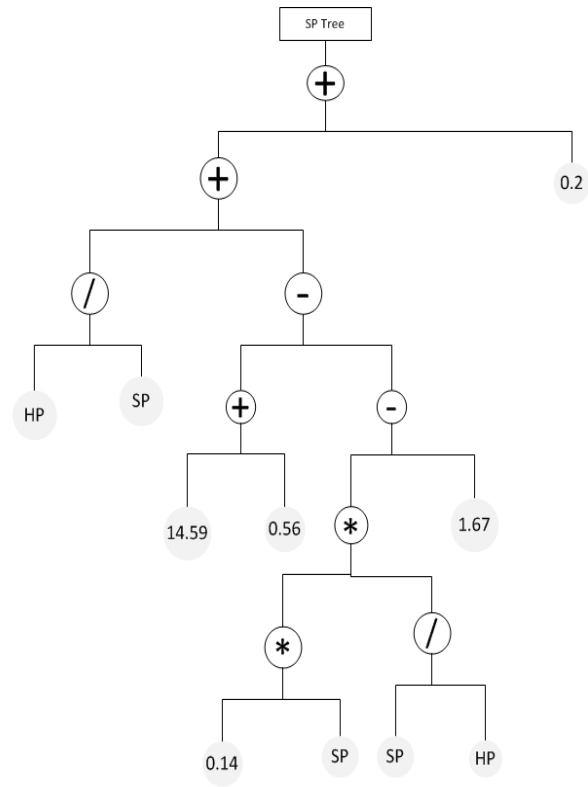
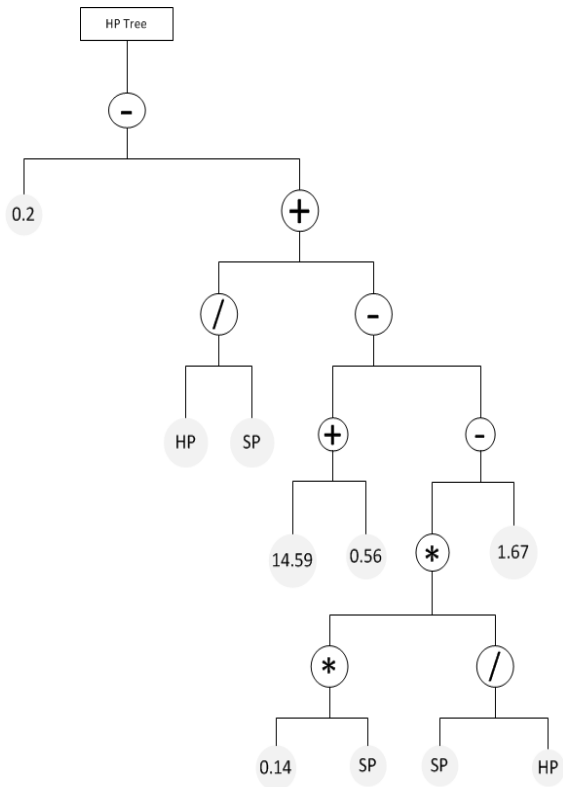

**With partial information conditions**

Terminal set	{ HP, SP random_constant(0,1)}
Functional set	{ + , * , / , - , max , min , sqrt , log , abs , pow , exp }
Population size	50 – 500
Best solution structure	(HP / exp((max((0.919952 - SP),max(0.790802,HP)) / exp(exp(0.825134))))))  (((HP - SP) - (SP - SP)) - 0.496124) - (0.626953 / HP))
Best solution structure simplified	$\frac{HP}{exp}$  $HP - SP - 0.5 - \frac{0.62}{HP}$

Target equations structure	$\left(\frac{SP}{0.5} - \frac{5 * HP * SP}{SP + HP}\right)$ $\left(\frac{5 * HP * SP}{SP + HP} - \frac{SP}{0.5}\right)$
Raw fitness	176.672
Adjusted Fitness	0.00562834
Tree depth	5
Population found in	450
Run found in	1
Generation found in	3

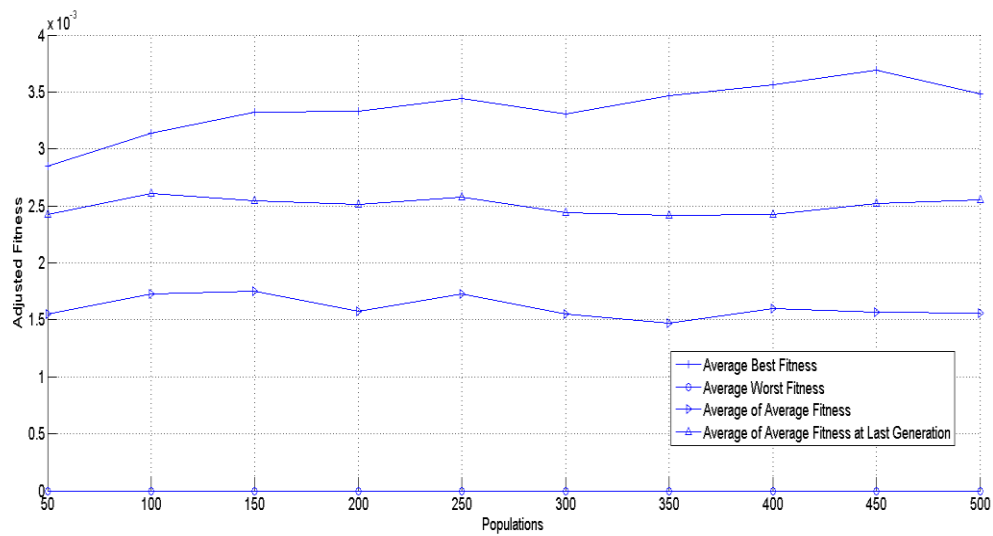

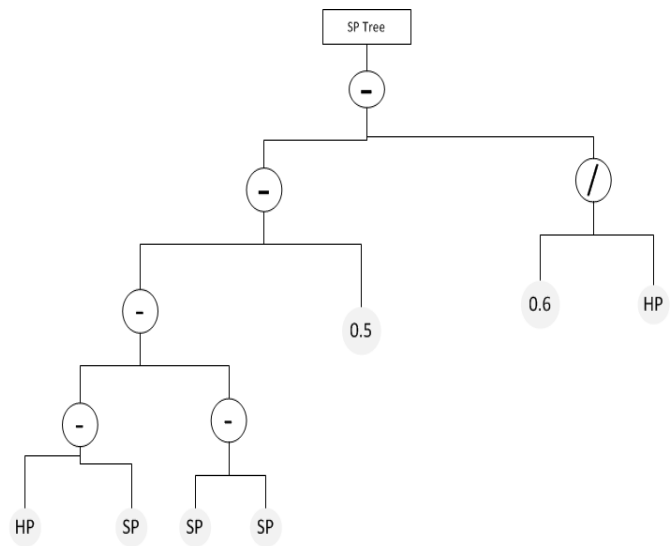
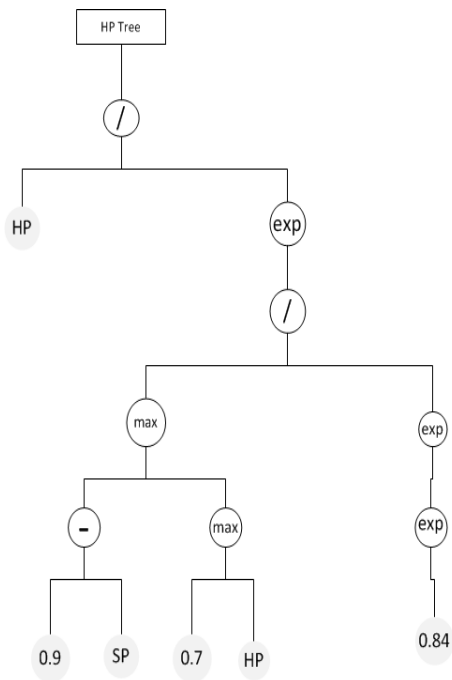
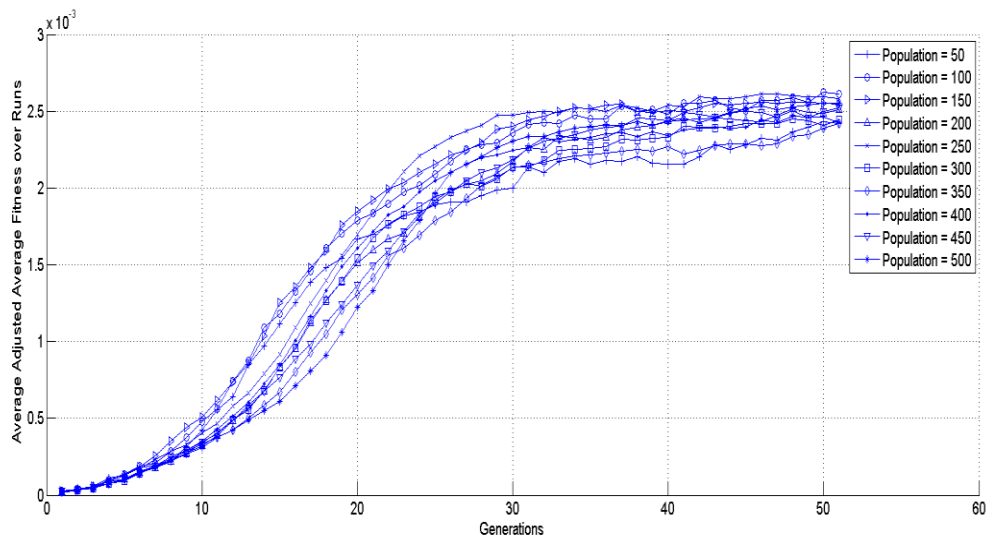
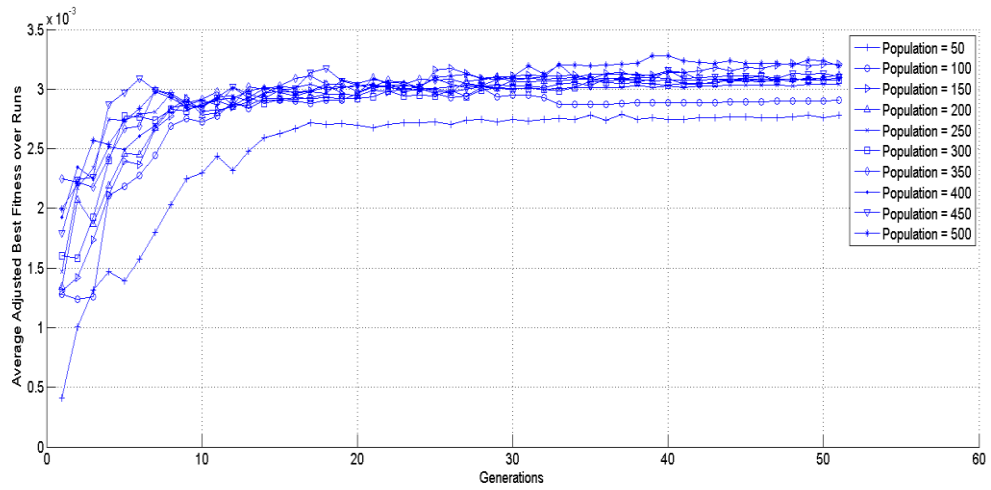

### Case study 3 GP configurations and fitness figures

#### With full information conditions

Terminal set	{ IP, SP, RP random_constant(0,1), random_constant(1, 10) }
Functional set	{ + , * , - , / }
Population size	50 - 1000
Best solution structure	(0.577423 - (RP / IP))  ((SP - (SP + IP)) / 0.986633)  (IP + (RP / IP))
Best solution structure simplified	$0.57 - \frac{RP}{IP}$  $\frac{-IP}{0.98}$  $IP + \frac{RP}{IP}$
Target equations structure	$\left( \frac{1.5 * SP * IP}{(IP + SP + RP)} - \frac{IP}{2} \right)$  $\left( - \frac{1.5 * SP * IP}{(IP + SP + RP)} \right)$  $\left( \frac{IP_t}{2} \right)$
Raw fitness	37298.2
Adjusted Fitness	0.00002681020

Tree depth	3
Population found in	900
Run found in	5
Generation found in	35

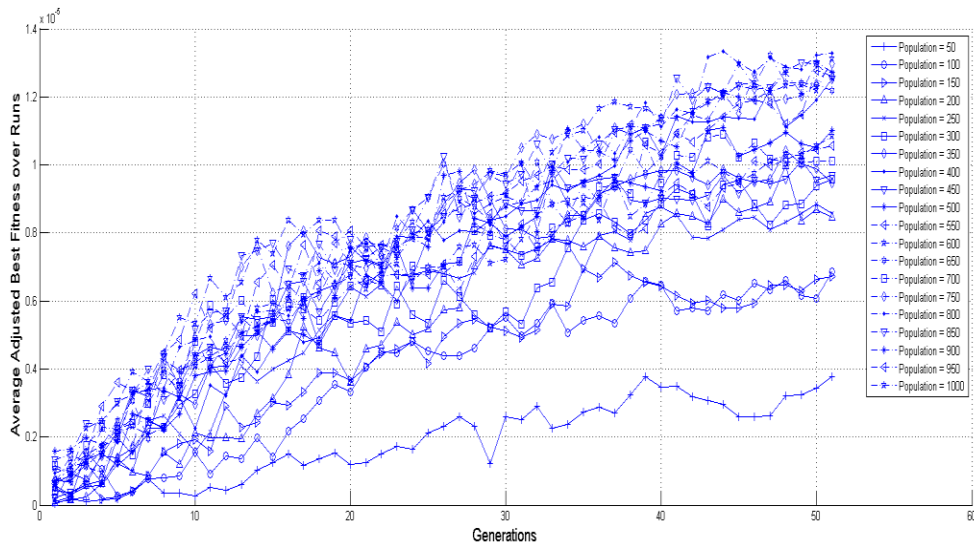
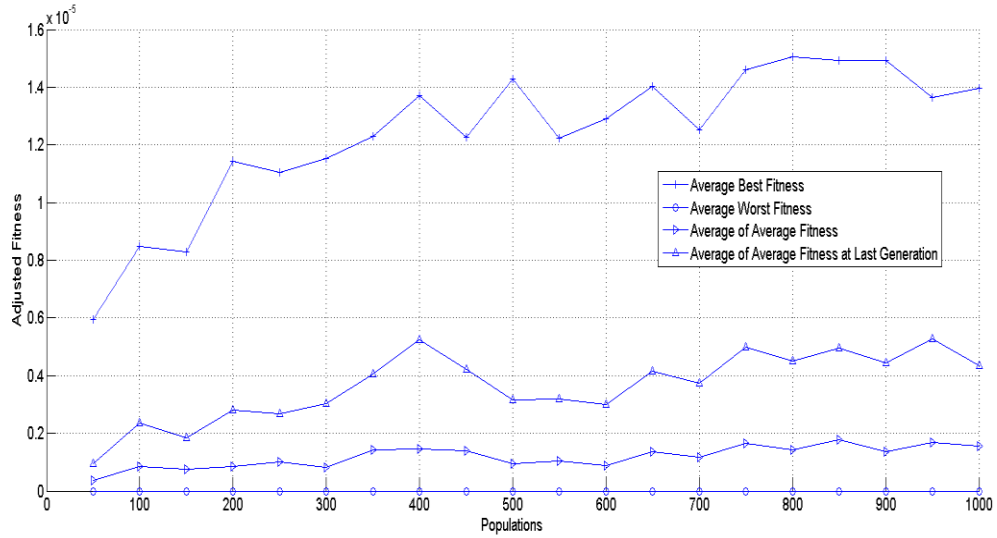

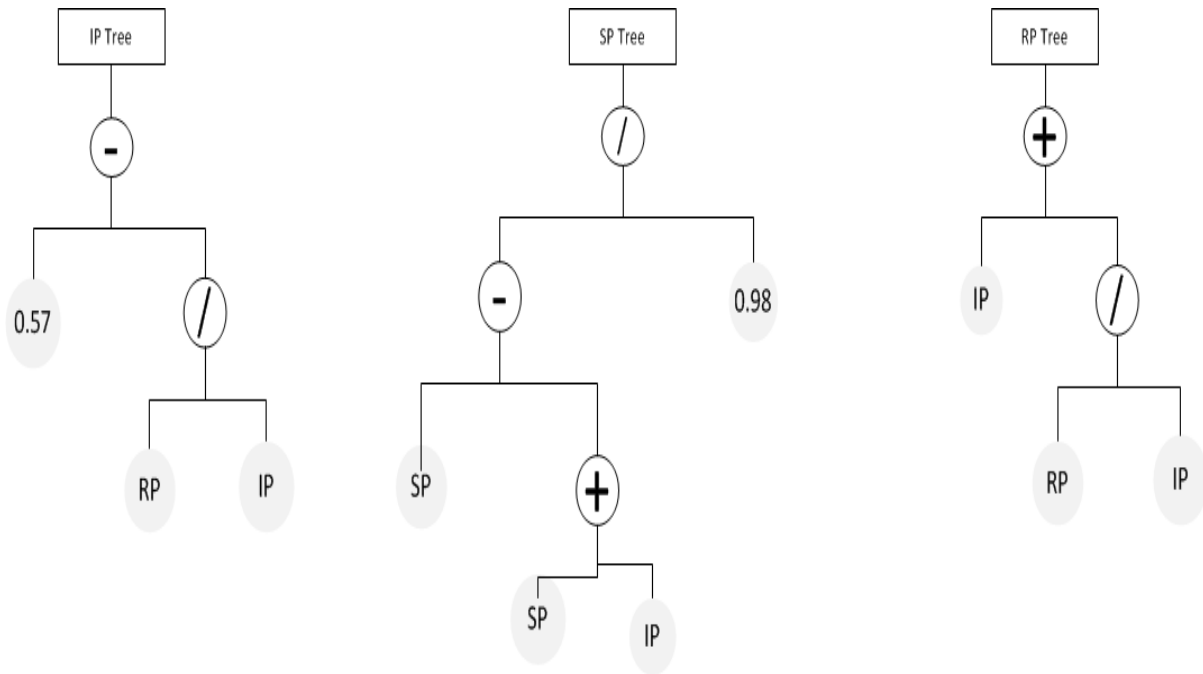
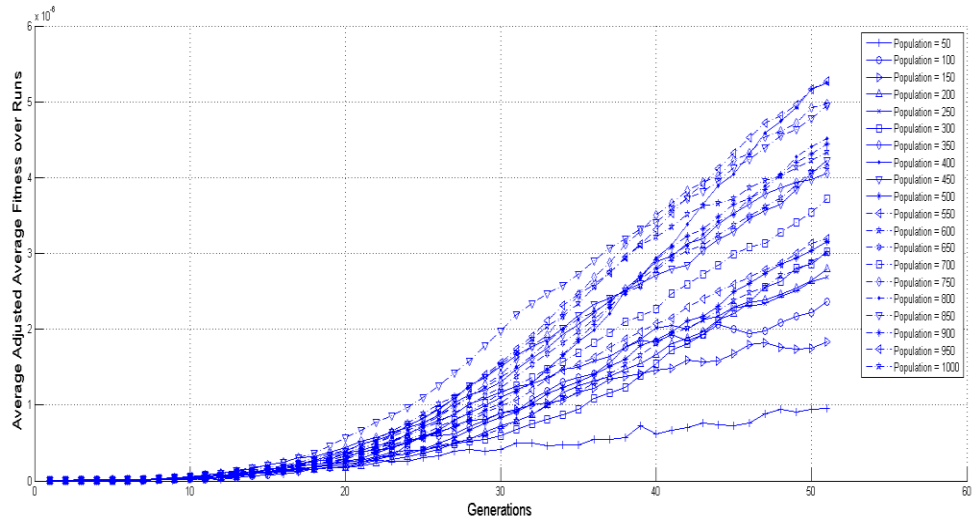

**With partial information conditions**

Terminal set	{ IP, SP, RP random_constant(0,1) }
Functional set	{ + , * , / , - , max , min , sqrt , log , abs , pow , exp }
Population size	50 - 1000
Best solution structure	(sqrt((0.728485 * IP)) - (0.728485 * IP))

	$(IP + (((0.514252 * SP) + (IP - SP)) / IP))$ $(IP / (((0.514252 * SP) + (IP - SP)) / IP))$
Best solution structure simplified	$\sqrt[2]{0.72 * IP} - 0.72 * IP$ $IP + \frac{IP - 0.5 * SP}{IP}$ $\frac{IP^2}{IP - 0.5 * SP}$
Target equations structure	$\left( \frac{1.5 * SP * IP}{(IP + SP + RP)} - \frac{IP}{2} \right)$ $\left( - \frac{1.5 * SP * IP}{(IP + SP + RP)} \right)$ $\left( \frac{IP_t}{2} \right)$
Raw fitness	12096.5
Adjusted Fitness	0.00008266200
Tree depth	4
Population found in	450
Run found in	4
Generation found in	37

