

MRP and JIT: Teaching the Dynamics
of Information Flows and Material
Flows with System Dynamics Modeling

Merrill E. Warkentin
University of Nebraska-Lincoln

Abstract

System Dynamics modeling is used as an instructional aid for the teaching of production and inventory management techniques. The roles of Material Requirements Planning (MRP) and just-in-time (JIT) systems in production and inventory management are presented and discussed. By modeling these manufacturing systems, the student can acquire an appreciation of the dynamic relationships between the elements of each system. Some elements of the Dynamo models of these systems are presented. The future opportunities and research needs are discussed.

Introduction

Every instructor of Production and Operations Management (P/OM) has experienced the frustration of trying to bring about a complete understanding of the several production and inventory management (P & IM) models. The Economic Order Quantity (EOQ) method, the Material Requirements Planning (MRP) methodology, and the newer "just-in-time" (JIT) approach are three tools used for organizing and controlling the manufacturing assembly line. These systems are usually described in a lecture, are compared and contrasted, and are left for the student to conceptualize. The limited homework and classroom problems serve as the only "hands-on" experience with such manufacturing management techniques. While well-written sources exist, it is often difficult to achieve thorough understanding of the dynamic characteristics of each system. Without any actual experience in observing the behavior of a shop floor under MRP or JIT conditions, the student can never really gain a full appreciation for the advantages, routine difficulties, and special-case problems of each system.

The technique of Dynamo modeling, developed during the 1950's by Jay W. Forrester at MIT's Sloan School of Management (Meadows 1980, p. 30), can be used to facilitate the instructor of such P & IM techniques. Because the primary goal is the teaching of the systems' characteristics under varying conditioners, Dynamo modeling is especially suited to this task. It provides the ability to generate generic standard models which can be "fine-tuned" and subjected to many individual internal and external events and changes.

Production and Operations Management

The production process can be viewed as a simple open system with inputs (capital, labor, managerial skills, etc.), the conversion process itself, environmental and other influences (economic fluctuations, political-legal-regulatory impacts, random factors, etc.), outputs (goods and services), and the various flows of information such as feedback from output monitoring (inventory levels, sales volume, plant efficiency, quality considerations, etc.). The information feedback elements of this system are complex and varied, and can be both positive and negative. Figure 1 shows the basic structure of this simple model. One major goal (desired behavior) of this system is efficiency (as measured by the relation between output quantities and input quantities). Another primary consideration is the level of quality of the output (as measured by consumer response, return rates, product test results, etc.).

Figure 1
The Basic Production Process Model

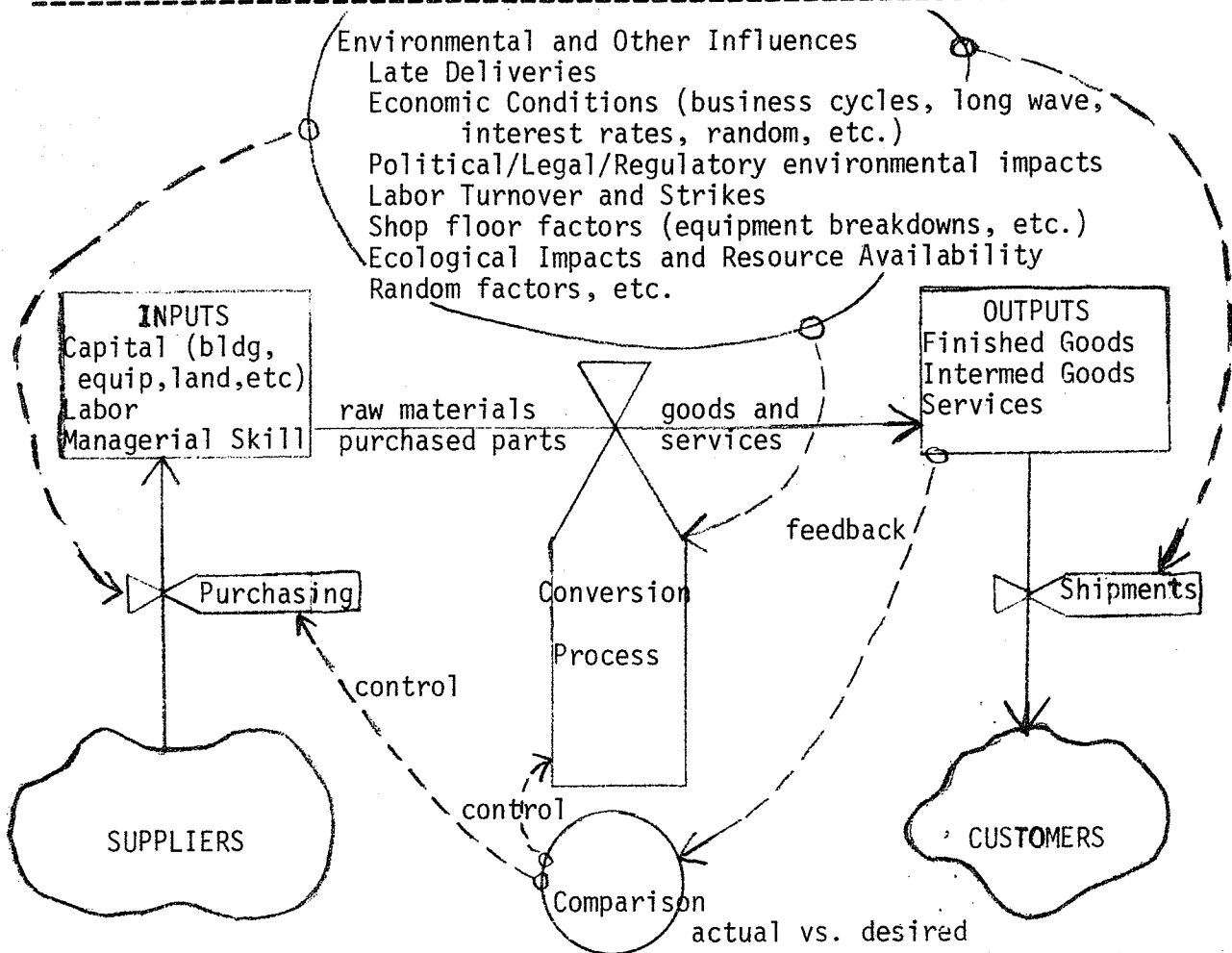

However, the real work of the manufacturing manager occurs within the conversion process itself. The methods employed for organizing and controlling the conversion of inputs into outputs have lately been given a great deal of attention by the P/OM profession. While many large companies with complex production systems have used Master Production Scheduling (MPS) for many years, the technique has only recently filtered down to many smaller companies with smaller budgets. At the same time, there is growing interest in new production management concepts. The American Production and Inventory Control Society (APICS) has a Zero Inventory Committee which advocates the conversion to stockless production. This rising interest in just-in-time (JIT) manufacturing has coincided with the growing concern over price competition and quality competition from the Japanese manufacturers.

Managers of American factories have employed various methods for organizing the production activity. Perhaps the oldest and simplest technique used to organize and control the mass-production assembly line is the economic order quantity (EOQ) method, where stocks are replenished when they reach the reorder point (ROP). This is a lot-for-lot "pull system" for stocking each inventory location in the system. When inventory levels at one point (purchased parts inventory, work in process, finished goods inventory, etc.) fall to some prescribed quantity, more parts are ordered (pulled). The order quantity is generally large so that scale economies (from purchasing, transportation, order-processing, and setup costs) can be realized. Yet the lot size or run size must not be so large that excessive carrying costs are incurred. Thus we speak of the "economic order quantity" or EOQ. Figure 2 graphically represents this derivation. Manufacturers that employ this algorithm "do so because of a difficulty in associating parts requirements with the schedule of end products." (Schonberger 1983, p. 64)

Figure 2
Economic Order Quantity

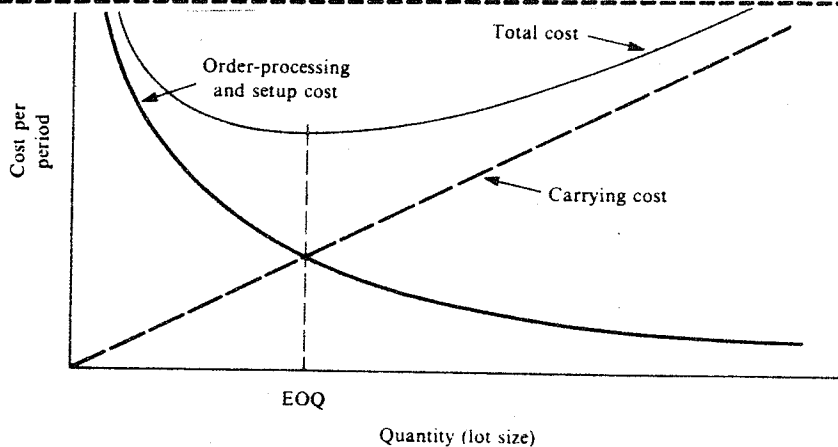

Material requirements planning (MRP), is yet another popular method for managing the production process. MRP, a critical com-

ponent of an overall manufacturing planning and control system, is a method for planning and controlling inventories so that sequential work centers are provided with the materials they require to produce the output planned by the Master Production Schedule (MPS). Finished goods inventory (FGI) levels are determined by the output of the demand management function. The intermediate inventory levels (work in process, WIP) are computed by the MRP system from current inventory levels and planned operations affecting inventories. Timing is very critical in the MRP system; future needs are set by the MPS, and the problem is calculating when to operate each work center in the system (and when to order). Each step in the process is "backscheduled"; the timing and quantity of the final stage can be easily calculated and used to calculate the second-to-last stage which is used to drive the production schedule for the stage before it. There is little flexibility in the order quantities because of lot size constraints (EOQ, setup costs, etc.). Equipped with the MPS, the EOQs, the setup times and costs, the bill of goods (BOG) information, and the current inventory levels, the MRP system can use a high-speed computer to solve the set of equations so that the production schedule for each work center (and thus the WIP levels) can be carefully calculated. The master schedule of finished goods is translated into a schedule for hundreds of parts requirements. This computer output is used to determine the material flow for the entire plant. It should be noted that MRP-organized plants also require "shop floor control" to fine-tune the computer-generated schedule. It is the job of the expeditors and shop managers to override the schedule determined by the computer if this becomes necessary. Figure 3 shows the basic design of this manufacturing planning and control system.

A third method for organizing the manufacturing process is the "just-in-time" (JIT) system. This concept is also referred to as stockless production, zero inventories, the Kanban system, and the pull system. Actually these terms are related, but each describes a unique concept. "The JIT idea is simple: Produce and deliver finished goods just in time to be sold, subassemblies just in time to be assembled into finished goods, fabricated parts just in time to go into subassemblies, and purchased materials just in time to be transformed into fabricated parts." (Schonberger 1982, p. 16) The just-in-time/total quality control (JIT/TQC) system is much more than an inventory replenishment system; it becomes a major influence on every aspect of the production process from purchasing through distribution. The reduction of lot sizes triggers a chain reaction of benefits in the plant. (Schonberger 1982, p. 18) In a JIT system, the ideal lot size is one. One of the benefits of minimum lot sizes is lower scrap with improved quality. "If a worker makes only one of a given number of parts and passes it to the next worker immediately, the first worker will hear about it soon if the part does not fit at one of the next work stations. Thus, defects are discovered quickly and their causes may be nipped in the bud; production of large lots high in defects is avoided." (Schonberger 1982, p. 25) The JIT system with its Kanban inventory control system is gaining in popularity in American plants because of the

many advantages it holds over the MRP system in most cases. For an example of a Kanban system, see Schonberger 1982, pp. 221-224.

Figure 3
Manufacturing Planning and Control System

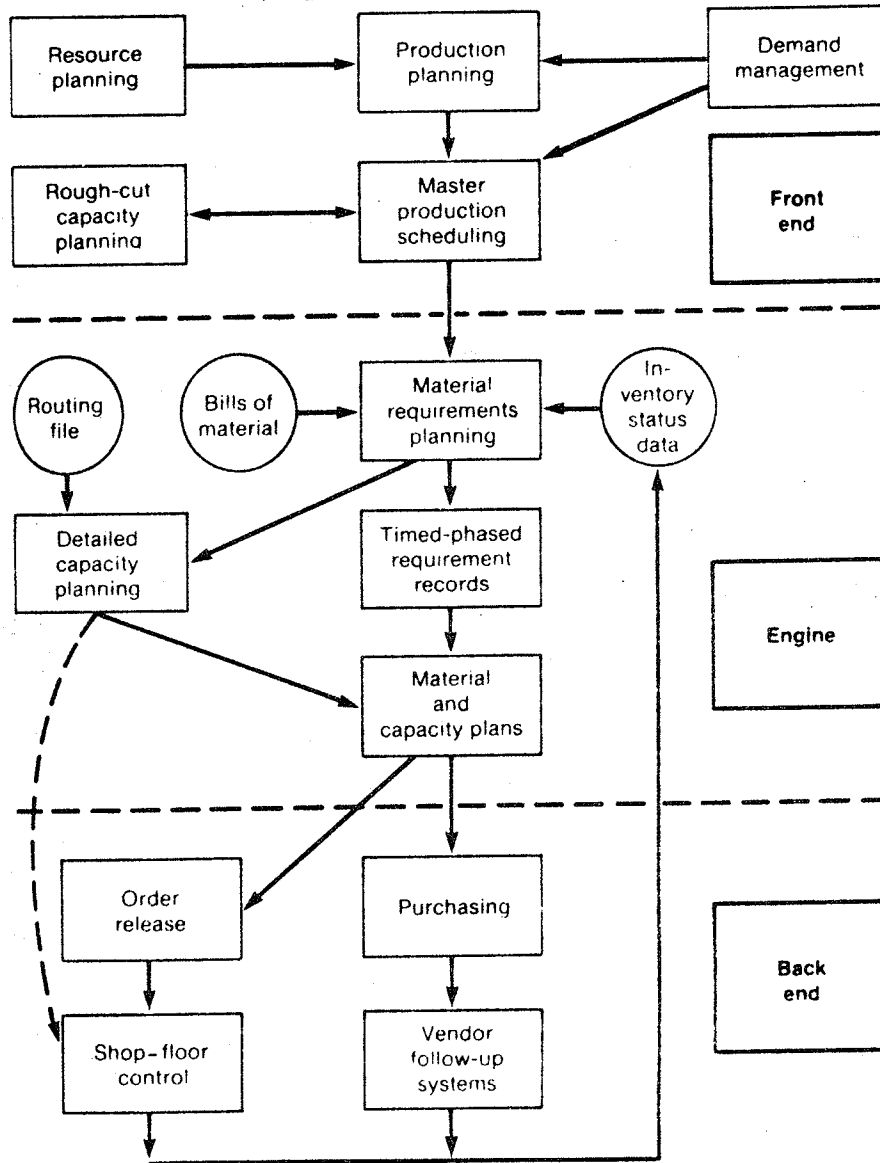

Vollman, et al. Manufacturing Planning & Control, 1984, p. 25.

The real distinction between these systems is their performance "under duress", their operation in the dynamic setting of the

factory floor. If demand is certain, if labor levels are given (no turnover, no strikes, etc.), if there are no machine breakdowns, and so on, any of these systems can be successfully employed as a management tool. But when production problems arise, and they will, each system exhibits a unique behavior with respect to the manufacturing system variables (see Figure 4). The dynamics of each system are the focus of this project.

P/OM Education Using Dynamo Modeling

The task of teaching Production and Operations Management concepts to young students can be both challenging and rewarding. One sometimes frustrating element of this charge is the description of the dynamics of inventory and information flows on the shop floor under various conditions and system controls. One innovative approach to enlightening the students is the use of a production game where each individual (or team of individuals) represents one work center in an assembly process. Each team has responsibility of managing its inventories through forecasting and ordering inputs. By introducing various parameter changes (such as demand pulses) into the game conditions, the participants can observe how the components react to the information flows with ordering activity and inventory adjustments.

A better approach to teaching these concepts is to allow the students to model the inventory management systems with the Dynamo simulation compiler. This System Dynamics approach is especially suited to the task. It allows the user to test a great variety of conditions and influences easily and quickly.

In order to use Dynamo modeling to teach P/OM, the instructor must first introduce the students to the basics of System Dynamics theory and Dynamo simulation language techniques. The goal is to teach the students as much of this body of knowledge as is necessary to facilitate the education of the production systems. Primary emphasis will be on MRP and JIT. Students must understand simple model behavior -- growth and decay, cyclical activity, and so on. They must also understand the information flows, positive and negative feedback, and general impact relationships between rates, auxiliaries, levels, and overall system parameters. By teaching the student these concepts, the teaching of any system will be substantially enhanced. Because the goal is not Dynamo modeling expertise, only basic techniques need to be presented; the students must possess basic proficiency at modeling the systems.

The overall production system (in Figure 1) is first presented to the students. This basic model contains two levels and three rates with additional auxiliary variables. The students are introduced to these variables using the terms "stocks" and "flows". The students are also presented with the information feedback element of this first model. The lecture and discussion should revolve around the feedback and control loops. By concentrating on these elements, the students will gain an appreciation

for the dynamic nature of the production system, its components, and its environment.

It is a reasonably straightforward task to diagram and describe the systems, their components, and the basic relationships to a large class of Introductory P/OM. But the real goal of any good instructor is to enlighten the students in the way these systems "really work"; that is, how they behave under realistic conditions. Only through a simulation exercise can the student gain a real appreciation for the way in which these systems operate under various environmental and internal influences. By carefully constructing a model of a JIT system, for example, the student must not only carefully think through the many relationships in the system, but he must also ensure that each relationship will be valid under extreme conditions (when production falls to zero, for example). By performing the validation tests, the student can ensure that the modeled system is logical and realistic. (If stock levels become negative, for example, the structure is probably inaccurate.)

Figure 4
Manufacturing System Variables

Inventory turns	Percentage of purchase discounts taken
Cost of inventory investment	Percentage of stockouts
Month's supply on hand	Machine utilization
Dollars of back orders	Indirect labor
Days to fill an order	Average shop order time
Customer service level	Percentage of order split because of shortages
Number of open purchase orders	
Number of open shop orders	
Percentage of orders expedited	

Adapted from COPICS Manufacturing Systems Workbook

These system components and their behavior under various system parameter combinations can be taught to the P/OM students using the Dynamo modeling exercise. After a brief introductory lecture, which might be accompanied by an instructional film, the instructor can direct the class through a group modeling session. Through this group decision process, the students can debate and formulate the system structure. At the next class meeting, the students can follow up and make any necessary changes to the equations in the model. Finally, they can run the model under a variety of model parameters. This process will ensure that they are able to witness the behavior of each component of the model under various conditions. In this way, the system's dynamic aspects can be elucidated.

Figure 5
Water Flow / Material Flow Analogy

1. With high levels of work in process inventory (WIP), the material (water flow) accumulates in inventory locations (deep pools). These bottlenecks, which slow the flow through the system, cannot all be seen from the surface.

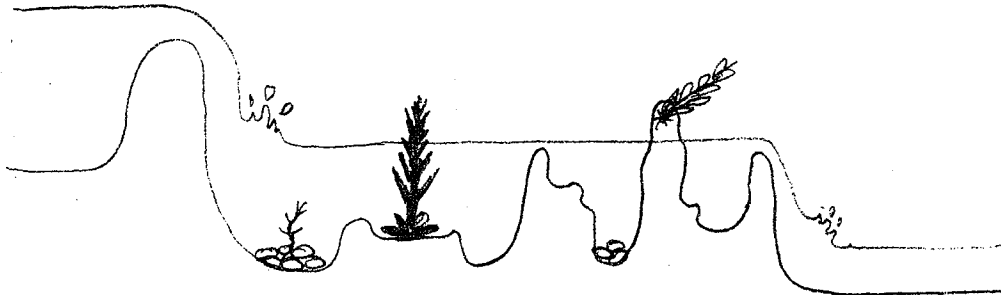

2. By reducing the level of WIP, the obstructions (rocks) are exposed. By solving these problems, the WIP level can be safely reduced again until new obstructions (more rocks) are uncovered. This process can continue incrementally until most of the hindrances have been remedied.

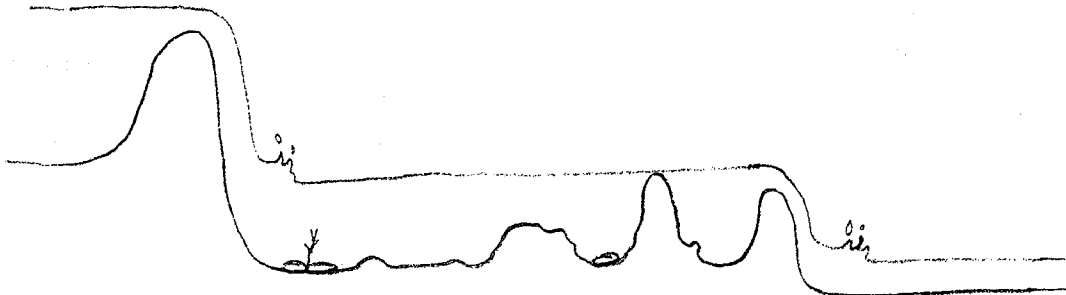

3. As the sources of material impedance are removed (the channel is cleared of rocks), the material flows through the system at a uniform rate of flow; the WIP is not allowed to accumulate. Therefore, any quality problem will be discovered by the next work center or inspection station. When problems are discovered, only a small lot will need to be reworked or discarded, rather than a large amount of inventory which has been accumulating like water in a pool.

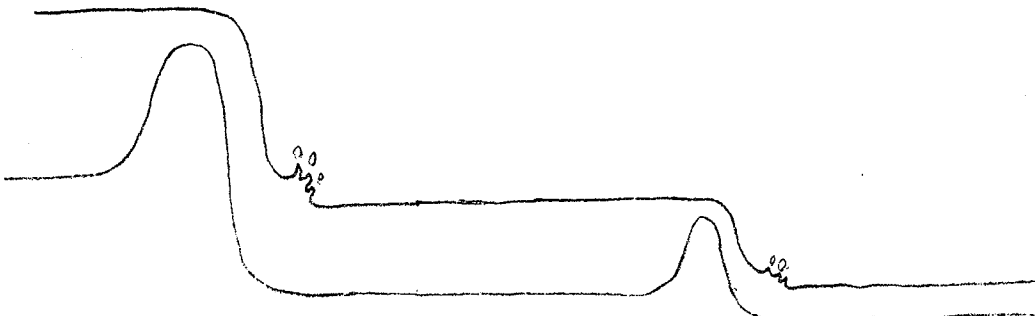

Material Stocks and Flows

It is said that the function of inventories is the decoupling or separation of the sequential stages in the production and distribution of a product so that successive stages can operate independently. If raw materials and purchased parts are delivered late, the maintenance of safety stock will preclude the need to shut down operations. Similarly, if buffers are maintained at work centers throughout the plant, the stopping of one machine due to malfunction or labor shortage will not dictate the need to shut down other work centers. Yet the maintenance of buffer stocks can also be viewed as a system for hiding inefficiencies, bottlenecks, and other problem situations which should be exposed and solved. Figure 5 depicts the water flow analogy (Hall 1983, p. 13, and others) which demonstrates the potential gains from reducing the work in process inventory level. This analogy demonstrates a primary reason for implementing a JIT or stockless production system. By uncovering these problems (rocks), the entire production system can be made to operate more efficiently. In addition, quality can be enhanced as potential sources of defects are exposed and removed. It has been said that the Japanese manufacturing companies produce small quantities of output "just in time" while their American counterparts produce wastefully large quantities "just in case."

The dynamics of these stocks and flows can be targeted in the model formulation stage. Rather than concentrating on exact measurement of the components of the Dynamo models, the qualitative impact of the information flows must be emphasized to the student modelers. And rather than emphasizing the mechanics of the production process, most students would learn a great deal more by discussing and modeling the general nature of the information flows and system controls.

MRP and JIT Dynamo Models

A hypothetical model which might be generated by the P/OM student for the JIT system is presented in Figure 6. While there can be no generic production system model because the BOGs and information delays are unique to each real-world system, the students will each generate unique models from which they can learn about these production systems. The MRP model is driven by a complex set of auxiliary variables which represent the Master Production Schedule and the Material Requirements Planning function. The JIT model, however, is simpler in design. Each work center is driven by the next with a single item of information -- the level of WIP between -- triggering the activity. In other words, work center #3 (a rate variable) does not become active (processing WIP) until the inventory location ahead of it falls to some small quantity. This can be visualized as essentially a chain of rates and levels with some delays built into the system.

Figure 6
Just-in-Time Model

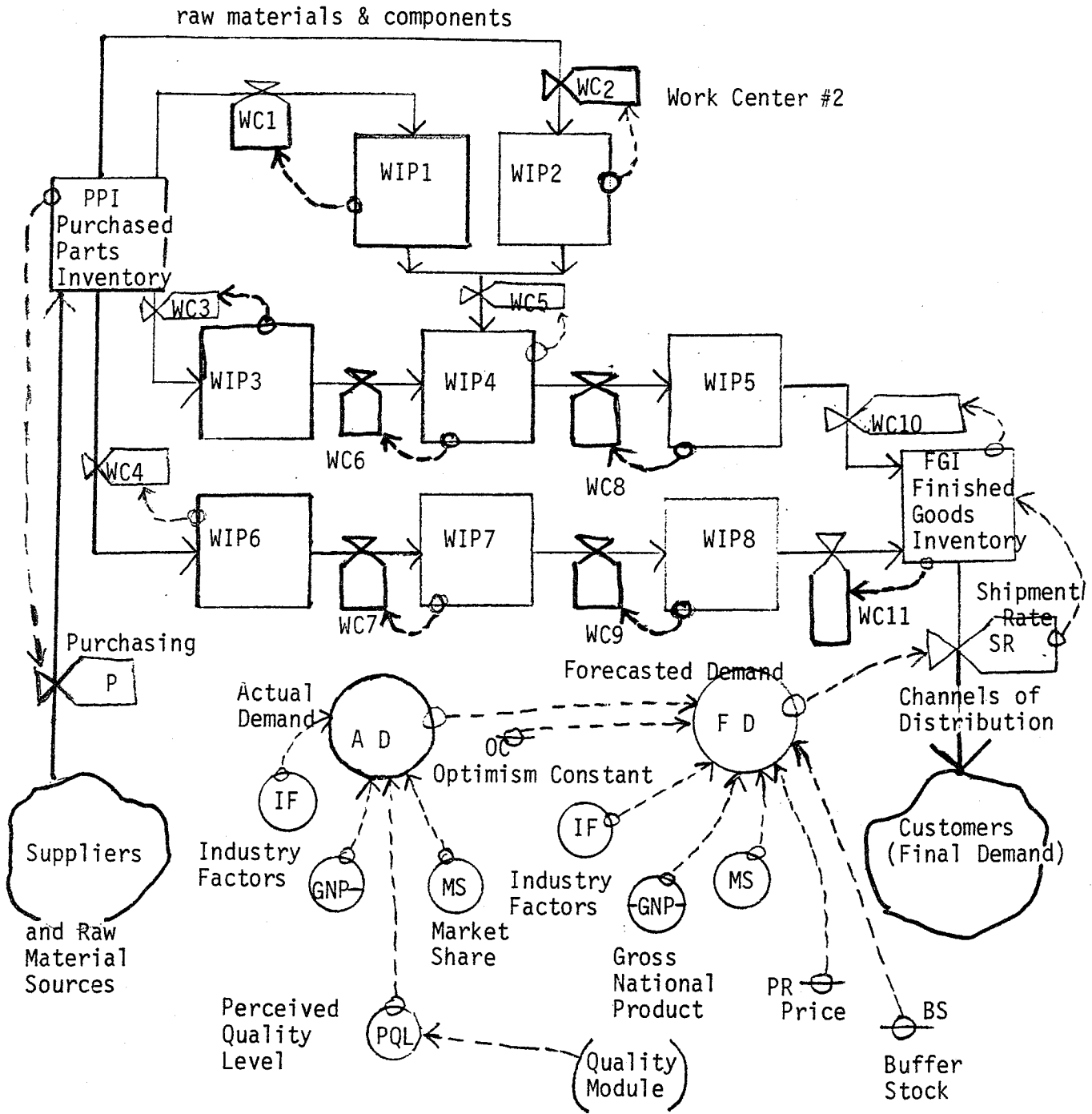

Conclusions

The many complexities of these systems of production could not be explored in this brief paper, but the reader can appreciate the relative difficulty of teaching the dynamic nature of their material and information flows. By modeling the several systems used in manufacturing, the student gains a greater appreciation of the relative complexity/simplicity of each system and of the systems' components and relationships. More importantly, as the student gains an appreciation for these relationships and the way in which each component (level or rate) affects, or is affected by, other system components, the overall dynamic behavior of the system becomes evident. After repeated simulation runs are followed by careful analysis, the students are able to acquire a comprehensive understanding of the manufacturing management systems. This approach to teaching P/OM concepts offers the prospect of greater comprehension of production systems and of their dynamics. This better understanding can be achieved in a classroom setting -- a distinctly appealing prospect in a field of study which is heavily practitioner-oriented and often difficult for many students to grasp.

A pilot study for the development of a general packaged approach to this exercise is being developed. By experimenting with several groups of students, areas of learning difficulty will be exposed and specific course procedures will be targeted for further development attention. This learning package should be presented upon completion of a set of required readings. This course of learning may be structured as a series of microcomputer modules that each individual student can "check out" from a software library and study at his or her own pace. However, the flexibility of this approach would be gained at the expense of the group interaction learning process.

The overall objective of the development of a useful tool for facilitating the instruction of P/OM concepts, particularly the MRP and JIT systems, requires careful planning, analysis, and design. Additional research toward this goal should include an analysis of the process which students normally experience when they are introduced to these inventory management systems. Do they readily envision the dynamic nature of the MRP and JIT systems? Do homework problems which show the student how to generate a simple schedule from demand data lead to systems thinking on the part of the average student? Does the introduction of system dynamics modeling overload the student with mental constructs and detract from his understanding of the production systems or does it unequivocally add to his understanding of the production process? These and many other questions need to be addressed as this project continues.

References

COPICS Manufacturing Systems Workbook, San Jose: CA: IBM
Manufacturing Industry Support Center, 1960.

- DeMott, John S. "Manufacturing is in Flower," Time, March 26, 1984, pp. 50-52. (with "In Quest of Quality," p. 52)
- Forrester, Jay W. Industrial Dynamics. Cambridge, Mass.: MIT Press, 1961
- Forrester, Jay W. "System Dynamics - Future Opportunities," TIMS Studies in the Management Sciences 14, pp. 7-12, North-Holland Publishing Company, 1980.
- Garvin, David A. "Product Quality: An Important Strategic Weapon," Business Horizons, March-April 1984, pp. 40-43.
- Hall, Robert W. Zero Inventories. Homewood, Ill.: Dow Jones-Irwin, 1983.
- Huang, Philip Y., Rees, Loren P., and Bernard W. Taylor III, "A Simulation Analysis of the Japanese Just-in-Time Technique (with Kanbans) for a Multiline, Multistage Production System," Decision Sciences 14, 1983, pp. 326-344.
- Meadows, Donella H. "The Unavoidable A Priori," in Elements of the System Dynamics Method, edited by Jorgen Randers, chapter 2, pp. 23-56. Cambridge, MA: MIT Press, 1980.
- Morecroft, John D. W. Influences from information technology on industry cycles, Ph.D. thesis, Sloan School of Management, MIT, 1979.
- Schonberger, Richard J. "Applications of Single-Card and Dual-Card Kanban," Interfaces 13:4, August 1983, pp. 56-67.
- Schonberger, Richard J. and Abdolhossein Ansari. "Just-In-Time Purchasing Can Improve Quality," Journal of Purchasing and Materials Management, Spring 1984, pp. 2-7.
- Schonberger, Richard J. Japanese Manufacturing Techniques: Nine Hidden Lessons in Simplicity, New York: The Free Press, 1982.
- Vollman, Thomas E., William L. Berry, and D. Clay Whybark. Manufacturing Planning and Control Systems, Homewood, Illinois: Dow Jones-Irwin, 1984.